

CA100
COMPACT CAL
USER'S MANUAL

Foreword

Thank you for purchasing the YOKOGAWA CA100 COMPACT CAL. This User's Manual contains useful information regarding the instrument's functions and operating procedures as well as precautions that should be observed during use. To ensure proper use of the instrument, please read the manual thoroughly before operating it. Keep the manual in the carrying case for quick reference whenever a question arises.

Note

- The contents of this manual are subject to change without prior notice as a result of improvements in the instrument's performance and functions.
- Every effort has been made in the preparation of this manual to ensure the accuracy of its contents. However, should you have any questions or find any errors, please contact your nearest YOKOGAWA representative listed on the back cover of this manual.
- Copying or reproduction of any or all of the contents of this manual without YOKOGAWA's permission is strictly prohibited.



Trademarks

- MS-DOS is a registered trademark of Microsoft Corporation.
- Company names and product names which appear in this manual are the trademarks or registered trademarks of the respective companies.

Revisions

1st Edition: March 1997
2nd Edition: June 1997
3rd Edition: October 1998

Conventions Used in This Manual

Type	Symbol	Meaning
Cautionary note		To avoid injury, death of personnel or damage to the instrument, the operator must refer to an explanation in the User's Manual.
		Calls attention to a procedure, practice or condition, which, if not correctly performed, adhered to, or maintained, could result in injury or death.
		Calls attention to a procedure, practice or condition, which, if not correctly performed, adhered to, or maintained, could result in damage to, or destruction of part of the product.
	Note	Calls attention to information which is important in the operation of the instrument.
Key	[] key	Represents a key on the front panel.

Checking the Contents of the Package

Unpack the box and check the contents. If the product is not the one you ordered, any item is missing or damage to any item is found, contact the dealer from whom you purchased the instrument.

Main Body

Check that the model name and suffix code given on the name plate on the back panel of the instrument match those on your order.

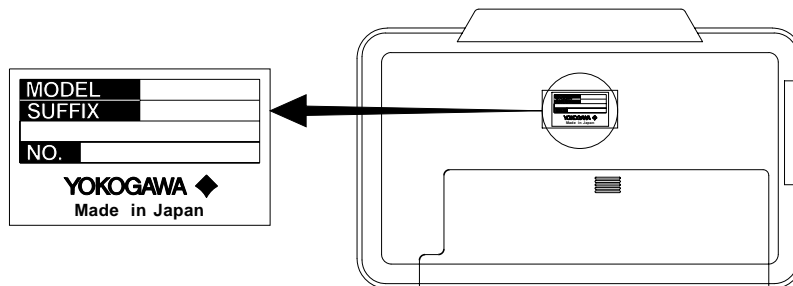

Type Name (MODEL) and Suffix Code (SUFFIX)

MODEL	SUFFIX	Specifications
255701		
Temperature Unit	-U3	selectable between °C and °F

Serial No.

Should you need to contact the dealer from whom you purchased the instrument, have your unit's serial number handy to give to the person.

Standard Accessories

The following standard accessories are supplied with the instrument. Make sure that all items are present and undamaged. Note that the dry cell holder (B9914CV) comes preinstalled in the main unit.

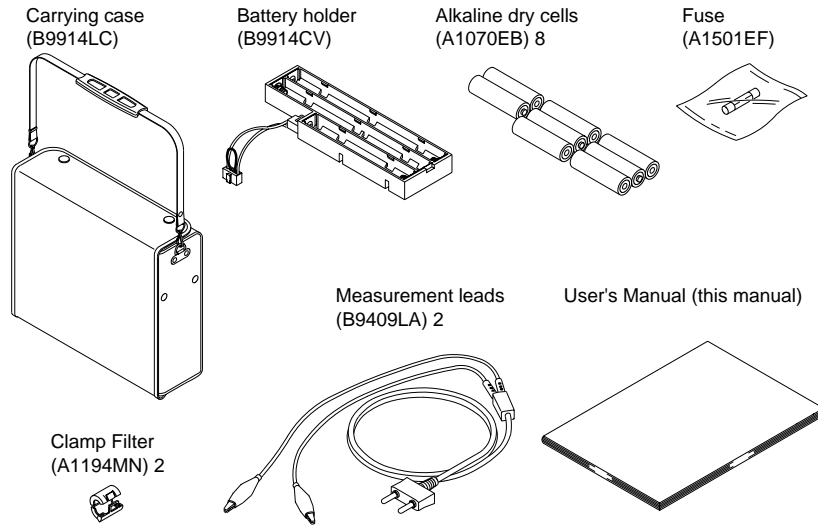

Optional Accessories

The following optional accessories are available. On receiving these optional accessories, make sure that all the items that you ordered have been supplied and that they are undamaged.

If you have any questions regarding optional accessories, or if you wish to place an order, contact the dealer from whom you purchased the instrument.

Name	Part No./ Type	Suffix Code	Remarks
AC power supply kit	366969		AC adapter (A1437UP 100 to 120/200 to 240 V AC, 50/60 Hz, output 15 V/1.33 A)
		-D	UL/CSA standard power cord (A1006WD) Maximum rated voltage: 125 V, maximum rated current: 7 A
		-F	VDE standard power cord (A1009WD) Maximum rated voltage: 250 V, maximum rated current: 10 A
		-Q	BS standard power cord (A1054WD) Maximum rated voltage: 250 V, maximum rated current: 10 A
		-R	SAA standard power cord (A1024WD) Maximum rated voltage: 240 V, maximum rated current: 10 A
Ni-Cd battery pack	B9914PS	-	Ni-Cd battery pack for this instrument*1
Fuse	A1501EF		For DMM current input protection 125 mA type Quick acting
RJC sensor	B9638CR		Sensor for reference junction compensation (x1)
Measurement lead	B9409LA		
Ferrite core*2	A1194MN		for use with leads (with a band)
	A1193MN		for use with connector for RJC sensor (with a band)
Input-terminal adapter	7515 12		Adapter for conversion from safety terminal to binding post

*1 When using a Ni-Cd battery pack, the AC power supply kit is also necessary.

*2 Neither the Measurement lead nor RJC sensor accessories come with ferrite cores. Include ferrite cores in your orders as necessary.

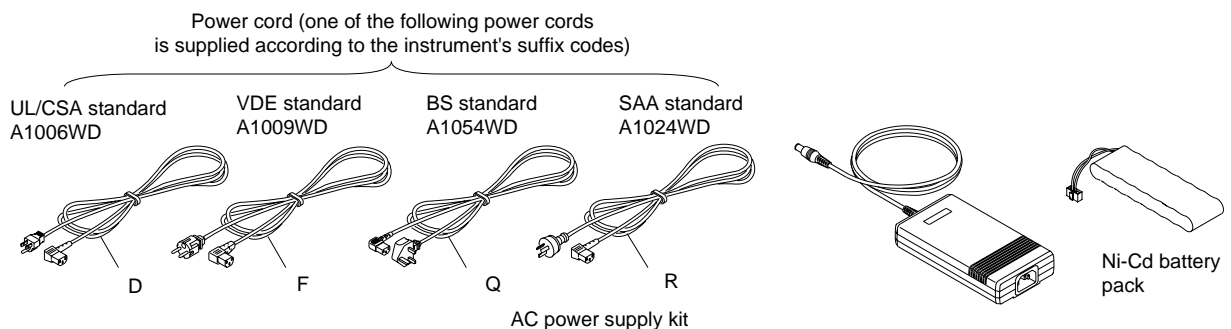

Safety Precautions

This instrument is an IEC safety class I instrument (provided with a terminal for protective grounding). The following general safety precautions must be observed during all phases of operation, service and repair of this instrument. If this instrument is used in a manner not specified in this manual, the protection provided by the instrument may be impaired. Also, YOKOGAWA Electric Corporation assumes no liability for the customer's failure to comply with these requirements.

General definitions of safety symbols used on the instrument and in this manual



To avoid injury, death of personnel or damage to the instrument, the operator must refer to an explanation in the User's Manual.



This instrument is protected by double insulation.



DC (Direct current)



Ni-Cd

Recycle

Make sure to comply with the following safety precautions. Failure to do so might result in a fatality or injury to personnel from such hazards as electrical shock, or damage to the instrument.

WARNING

Prohibition of Using the Instrument in a Gaseous Environment

Do not operate the instrument in the presence of inflammable and explosive gases or vapors. Operation of the instrument in such an environment constitutes a safety hazard.

Necessity of Protective Grounding

Never cut off the internal or external protective grounding wire or disconnect the wiring of protective grounding terminal. Doing so poses a potential shock hazard.

Defect in Protection Feature

Do not operate the instrument if there is a defect in protective grounding or fuses. Before commencing operation, always make sure that the protection feature is fault-free.

External Connection

After making sure that grounding is properly carried out, connect the protective grounding before connecting to the measurement or control unit. If you need to touch the circuit, you must turn off the switch and make sure that no voltage is generated.

Fuse

To prevent a fire, be sure to use fuses with the specified ratings (voltage, current, type). Before replacing fuses, turn the power off and disconnect the power source if you are using an AC power supply kit. Do not short-circuit the fuse holder.

Removing Covers

There are some areas under high voltage. Do not remove the cover if the power supply is connected. The cover should be removed by qualified personnel only.

To use the AC power supply kit (optional) safely, please comply with the following precautions.

WARNING**Protective Grounding**

To prevent electrical shock, be sure to connect the protective grounding before turning on the power.

Power Cord and Plug

To prevent electrical shock or fire, be sure to use the power cord supplied by YOKOGAWA. The main power plug can only be plugged in an outlet with a protective grounding terminal. Do not invalidate protection by using an extension cord without protective grounding.

Power Supply

Ensure that the source voltage matches the voltage of the power supply before turning on the power.

Safety Precautions for Using Ni-Cd Battery

Storage

- Please remove the Ni-Cd batteries from the main unit when storing.
- Do not leave the batteries in a hot-temperature environment such as under direct sun light, inside an automobile, or near fire, because this leads to leakage of the alkaline electrolyte.
- For long-term storage (6 months to 2 years), select a location where the humidity is low and the temperature is in the range from 10 to 25 °C.
- When charging for the first time after long-term storage, deactivation of the reactants may have led to decreased battery capacity, but this problem is restored after several cycles of charging and discharging.
- When storing the batteries for more than 6 months, please charge or discharge then recharge the batteries at least once per year to prevent leakage and the decline of performance.

Battery Life

The time of operation of the batteries gradually decreases with repeated use, even when the batteries are fully charged. Though it depends on the condition of use, take 2 years or 500 times as a measure to have the batteries replaced. (A typical battery life is 2 years or 500 times.) Please also note that prolonged storage leads to shortened battery life.

Charging

- Do not charge the batteries in any other instrument.
- Only charge batteries that are completely discharged. Charging batteries that are partially charged results in overcharging. This shortens battery life.
- Avoid overcharging the batteries, because this leads to shortened battery life.
- Charging the batteries for a long time may cause leakage of gases and electrolytes.

WARNING

- Do not disassemble or alter the batteries in any way.
The electrolyte inside the batteries is strong alkaline which can damage skin and clothes. Be especially careful of the electrolyte entering the eye, because it may cause blindness.
- Never short the batteries. Heat generated by the batteries may cause burns.
- Never heat or throw the batteries into fire. The batteries can rupture or the electrolyte may spray out.
- Never put water on the batteries or immerse them in water.
Such actions can cause heat to be generated or lead to rusting as well as the loss of ability to function.
- Do not use the batteries in any other instrument. The difference in the specification can cause damage to the other instrument.
- Do not pull the cable of Ni-Cd battery back or connector with excessive force.

Note

- Ni-Cd batteries are currently designated as recycle parts and collecting them is an obligation. Please send old batteries to your nearest YOKOGAWA representative listed on the back cover of this manual.
-

Contents

Foreword

Conventions Used in This Manual

Checking the Contents of the Package

Safety Precautions

Components and Their Functions

Block Diagram	9
Functions	9
Front Panel	10
Side Panel	12
Rear Panel	13

Before Starting Generation or Measurement

Usage Precautions	14
Installation Conditions	15
Installing Ferrite Core	15
⚠ Installing Dry Cells	16
⚠ Supplying AC Power (Optional)	17
⚠ Attaching and Charging Optional Ni-Cd Battery Pack	18
Turning the Power Switch On and Off	20
Turning Backlighting On and Off	20
Averaging, Key Type, International Temperature, Temperature Unit Settings	21

Generation

⚠ Connecting the Output Terminal	23
Before Generation	23
DC Voltage, DC Current, Resistance	24
Thermocouple, Resistance Temperature Detector	26
Frequency, Pulse Signal	28

Measurement

Connecting the Input Terminal	30
Measuring the DC Voltage, DC Current, and Resistance	31

24 V DC Power Supply

⚠ Connecting the Output Terminal	32
Turning Output On and Off	32

Using the RS-232-C Interface

RS-232-C Interface functions	33
Specifications	33
Connecting the RS-232-C Interface Cable	34
Settings for Communication	35
Before Programming	39
Using Talk-Only or Printer Mode	39

Troubleshooting

Items to be Checked in the Case of an Abnormality	40
Error Codes and Corrective Actions	40

Maintenance

Calibration	41
Replacing the Ni-Cd Batteries	50
Replacing the Backlighting EL	50
⚠ Replacing the Fuse	50

Specifications

Generation Functions	51
Measurement Function	53
Generation Section	54
Measurement Section	54
24 V DC Supply Section	54
Communications Function	54
Common Specifications	54
External Dimensions	55

Appendix

Communication Commands	App-1
Status Byte Format (for <ESC> command)	App-5
Output Format of Measured Data	App-5
Output Format for Talk-Only or Printer Mode	App-6
Output Format for Setting Information	App-6
Sample Program	App-7

Index

Components and Their Functions

Block Diagram

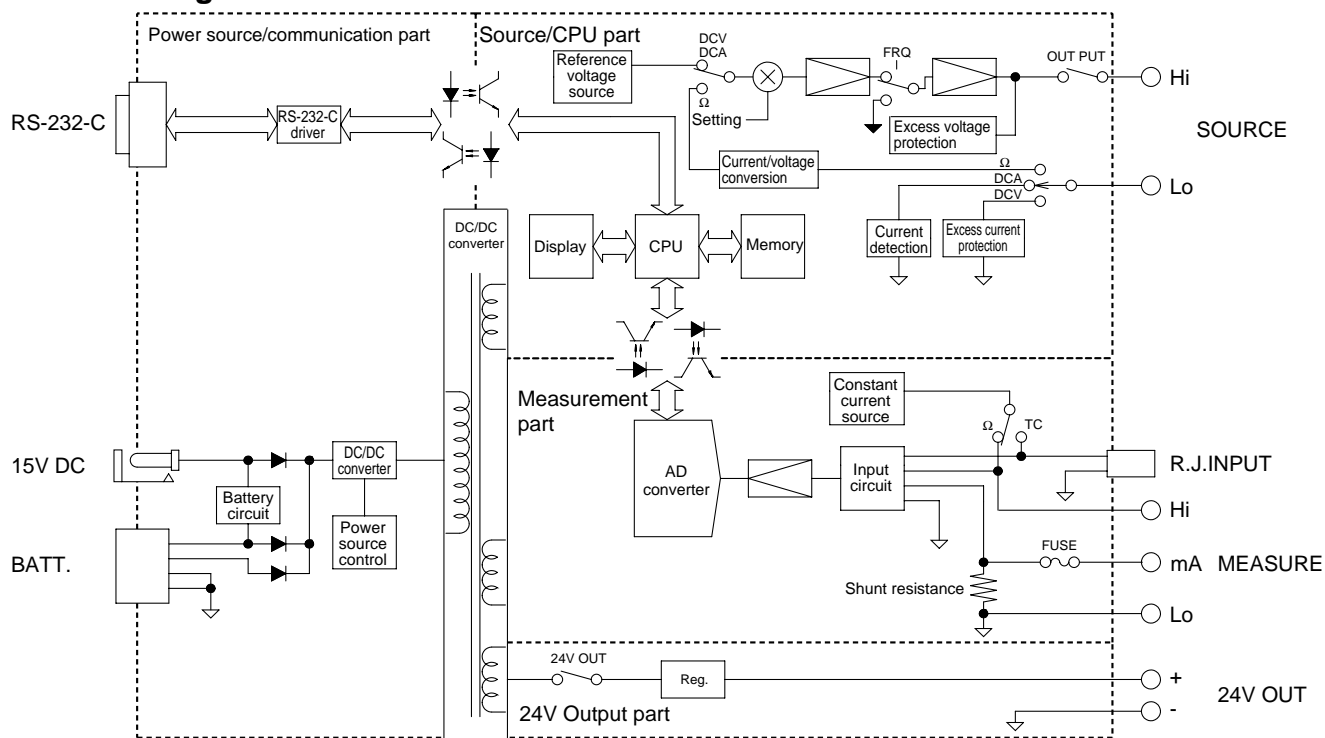

Functions

- **Generation Functions**

A specified value (in five digits) in function units of voltage, current, resistance, thermocouple, resistance temperature detector (RTD), frequency, or pulse signal can be generated.

Function	Description
DC voltage	Available in three ranges: 100 mV, 1 V, or 10 V
Direct current	Available in 20-mA range. SINK function is also available.
Resistance	Available in 3 ranges: 500 Ω, 5 kΩ, or 50 kΩ
Thermocouple	Thermoelectromotive force can be generated according to the temperature of type K, E, J, T, N, R or B thermocouple.
Resistance temperature detector	A resistance can be generated according to the temperature of PT100 resistance temperature detector.
Frequency and pulse signal	Frequency is in four ranges: 100 Hz, 1000 Hz, 10 kHz, or 50 kHz. Voltage is in the same range as the 10 V range for voltage generation. Pulse signals with a specified number of bursts (1 to 60000) are available as well as the above.

- **Measurement Function**

Voltage, current, or resistance can be measured and displayed in 4.5 digits independent of the generation function.

Function	Description
DC voltage	Available in three ranges: 500 mV, 5 V, 35 V
Direct current	Available in two ranges: 20 mA, 100 mA. An overrange input protection fuse comes built into the current-input terminal.
Resistance	Available in three ranges: 500 Ω, 5 kΩ, or 50 kΩ

The following functions can be selected:

Function	Description
Averaging	Displays the results of moving averages of measured data. This is useful if the measured data are unstable or poor due to noise. (See page 21.)
Display hold	Halts updating of the displayed measured value.

- **24 V DC power supply**

This is a floating output. Available up to 24 V/22 mA DC max.

- **Communications function**

Using this function, the instrument can be controlled or measured data can be transferred to a personal computer via an RS-232-C interface (D-sub 9 pin). This function also allows the output of setting information or measured data to an ESC/P-support printer.

- **Three-way power supply**

Three types of power supply: AA cells, AC adapter (free selection of AC voltages, optional), and Ni-Cd battery pack (optional) are available.

Front Panel General View

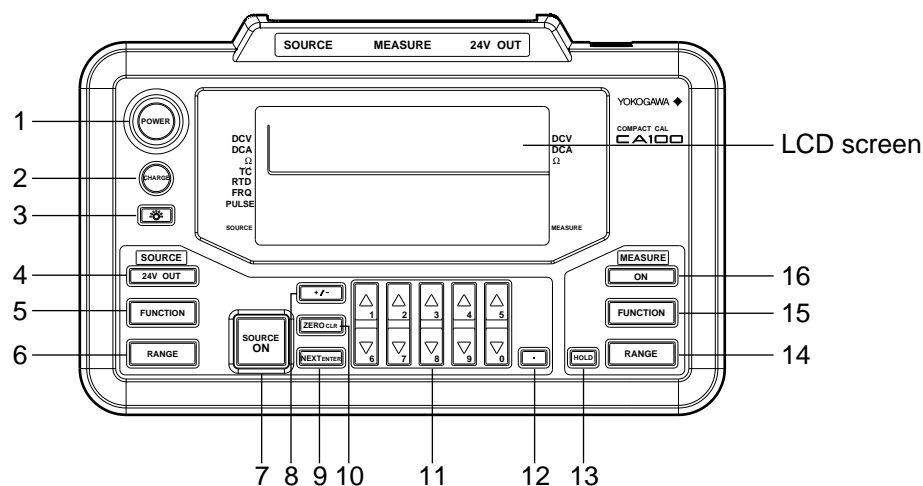

- 1 Power switch
Turns the power on and off.
- 2 Charging start key
Begins the charging of the Ni-Cd battery pack (optional).
- 3 Backlight key
Turns backlighting on and off.

Operation keys for generation

- 4 24 V DC power supply key
Turns the 24 V DC power supply on and off.
- 5 Function selection key
Selects one of the generation functions: voltage, current, resistance, thermocouple, RTD, frequency, and pulse.
- 6 Range selection key
Selects the range for setting generation values. For thermocouple or RTD, selects TC or RTD type.

- 7 Output on and off key
Turns output on and off.
- 8 +/- key
Toggles the polarity of the output value.
- 9 NEXT ENTER key
This switches the associated settings when setting the output values for the frequency and pulse signal. It also fixes the entered value when using the numeric keypad (refer to the following description).
- 10 ZERO CLR key
This resets the output value set to zero when using the up/down key (refer to the following description). When using the numeric keypad (refer to the following description), the value being entered is canceled and the previous set value is restored.
- 11 Output value setting keys
This sets the output value for the generation function. Either of the following two key modes can be selected from the menu. The up/down key mode is selected as the factory default setting.
Up/down key: This increments or decrements the values by one count for each digit corresponding to the [▲]/[▼]. If you try to increment or decrement using this key with value 9 or 0, the current digit moves up or down by one digit.
Numeric keypad: This enters numbers 0 to 9 directly from the keypad.
- 12 Decimal point key
This enters the decimal point when using the numeric keypad (refer to the above description). When this key is pressed, the digits to the left of the decimal point move to the positions specified on a range basis. When using the up/down key, this key is unavailable.

Operation keys for measurement

- 13 Display hold key
This retains displayed values as they are.
- 14 Range selection key
This selects the measurement range.
- 15 Function selection key
This selects one of the measuring functions: voltage, current, or resistance.
- 16 Measurement on and off key
This turns measurement on and off.

LCD Screen

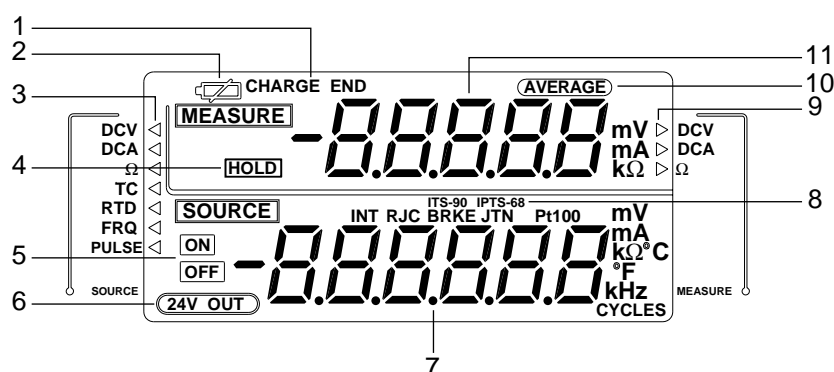

- 1 State-of-charge indicator
When using Ni-Cd batteries (optional), this indicates its charge status (CHARGE indicates charging is taking place and CHARGE END indicates charging has completed).
- 2 Low-battery indicator
This lights up when the battery becomes weak.

- 3 Generation function indicator
◀ indicates the currently selected generation function. Each press of the FUNCTION key changes the function from DCV to DCA, Ω , TC, RTD, FRQ, and PULSE in order.
- 4 Hold indicator
This indicates the measured value is held.
- 5 Output on and off indicator
On: indicates the output is turned on.
Off: indicates the output is turned off.
- 6 24 V DC power supply indicator
This indicates 24 V DC power is being supplied via the 24 V DC output terminal.
- 7 Generation range and output display
For voltage, current, resistance, frequency, and pulse: This indicates the decimal place and unit available for setting when selecting a range. Use the up/down key or numeric keypad to specify a value.
For thermocouple or resistance temperature detector: This indicates the type of TC, either thermocouple (TC) or resistance temperature detector (RTD), and the temperature available for setting (e.g., 00°C), when selecting a range. Use the up/down key or numeric keypad to specify the temperature.
- 8 International temperature standard display
This displays the international temperature standard currently selected.
- 9 Measurement function display
▶ displays the measuring function currently selected. Pressing the FUNCTION key changes the function from DCV to DCA and Ω .
- 10 Averaging indicator
This indicates that the averaging function is active.
- 11 Measurement range and measured value display
This indicates the decimal place and unit available for setting when selecting a range. When the measuring function is activated, the measured value is displayed.

Side Panel

Left side as viewed from the front

The following diagram shows the state when the cover is opened:

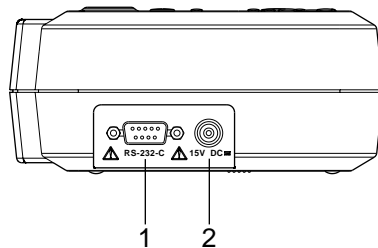

- 1 RS-232-C connector
RS-232-C communication interface connector
- 2 AC adapter jack (input)
This connects to an optional AC adapter.
Rated input voltage 15 V DC
Maximum rated input current 0.5 A DC

Terminal Side

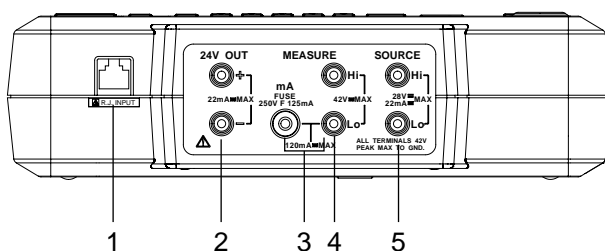

- 1 RJ45 sensor input connector
This connects to an RJ45 sensor (optional).
- 2 24 V output terminal
This supplies 24 V DC power.
- 3 Current input terminal
This is used when measuring current.
- 4 Voltage/resistance input terminal
This is used when measuring voltage or resistance.
- 5 Output terminal
This outputs the specified source.

This instrument falls under Overvoltage category II (CAT II). Overvoltage (installation) category indicates the impulse withstand voltage level which is regulated by IEC1010-1.

Rear Panel

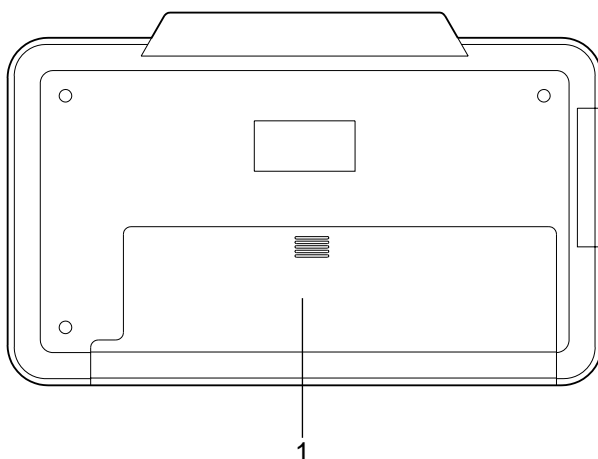

- 1 Battery storage
This holds the attached dry cells or the optional Ni-Cd battery pack.



CAUTION

- Before turning on the power switch, make sure the battery housing is shut with the cover on properly. Do not open the cover while the instrument is in operation.

Before Starting Generation or Measurement

Usage Precautions

Safety Precautions

- Before using this instrument, thoroughly read the "Safety Precautions" on pages 4 and 5.
- Do not remove the cover from the instrument.
Some parts of the instrument use high voltage, which is extremely dangerous. When the instrument needs an internal inspection or calibration, contact your nearest Yokogawa representative as listed on the back cover of this manual.
- In case of abnormality
If you notice smoke or the instrument seems to be acting abnormally, for example, it generates smoke or emits a strange odor, immediately turn the instrument off and, if an AC power supply kit is in use, disconnect the power cord from the AC outlet. Also turn off the object connected to the input terminal. If the instrument seems to be abnormal, contact your nearest Yokogawa representative as listed on the back cover of this manual.
- AC adapter and power cord
Use the dedicated AC adapter. Nothing should be placed on the AC adapter or power cord; also, it should be kept away from any heat sources. When unplugging the power cord from the AC outlet, never pull the cord itself. Always hold the plug and pull it. If the power cord is damaged, contact your dealer. Refer to page 3 for the part number to use when placing an order.

General Precautions when Handling the Instrument

- When moving the instrument
Turn off the power to the object connected to the instrument. Turn off the power to this instrument and, if an AC power supply kit is in use, disconnect the power cord from the AC outlet. When carrying the instrument, always use the carrying case.
- Keep input terminals away from electrically charged articles as they may damage the internal circuitry.
- Do not allow volatile chemicals to come into contact with the case or operation panel. Also do not leave them in contact with any rubber or vinyl products for prolonged periods. The operation panel is made of thermoplastic resin, so take care to avoid contact with any heated articles such as a soldering iron.
- Before cleaning the case and operation panel, make sure that the power cord is disconnected from the AC outlet if the AC power supply kit is used. Dampen a clean soft cloth with water and wipe the surface of the case and panel. Water that gets inside the instrument may result in breakdown.
- If the AC power supply kit will not be used over a long period, unplug the power cord from the outlet.
- For handling dry cells, refer to the section, "Installing Dry Cells," on page 16.
- Do not use the instrument with the cover for the battery housing left open.
- Gently wipe the surface with a soft and dry cloth. Do not use chemicals such as benzene or thinner, because these may cause discoloration and deformation.
- Do not stack the instrument.

Installation Conditions

The instrument must be installed in a place where the following conditions are met.

- Ambient temperature and humidity
Ambient temperature: 5 to 40°C (5 to 30°C for charging during generation or measurement)
Ambient humidity: 20 to 80% RH (no condensation)
- Flat horizontal location
Set the instrument in a level, stable place.

Never install the instrument.:

- In direct sunlight or near sources of heat
- Where the level of mechanical vibration is high
- Near noise sources such as high-voltage equipment or power lines
- Near strong magnetic field sources
- Where an excessive amount of soot, steam, dust or corrosive gases are present.
- In an unstable place
- Where explosions caused by inflammable gases or the like are possible

Note

- To ensure high measurement accuracy, the instrument should be used under the following conditions:
Ambient temperature: $23 \pm 5^\circ\text{C}$
Ambient humidity: 20 to 80% RH (no condensation)
When using the instrument in temperature ranges of 5 to 18°C or 28 to 40°C, add the temperature coefficient specified in the "Specifications" on page 51 to the accuracy.
- If the ambient humidity of the installation site is 30% or below, use an anti-static mat to prevent static electricity.
- Internal condensation may occur if the instrument is moved to another area where both the ambient temperature and humidity are higher, or if the room temperature changes rapidly. In such cases, acclimatize the instrument to the new environment for at least one hour before starting operation.

Installing Ferrite Core

This instrument is CE Mark compliant. When using the measurement lead, make sure to attach the accessory clamp filter on it according to the directions indicated below. In addition, when purchasing the optional measurement lead or RJC sensor, make sure to purchase the clamp filter also and attach it according to the directions indicated below. Note that if the clamp filter is not properly attached or used, the standard cannot be satisfied.

Installation

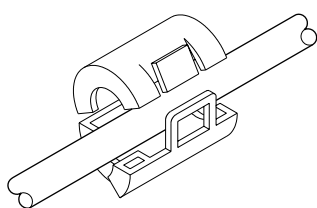

- Guide the cable through the clamp filter and lock the core.

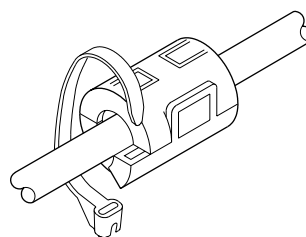

- Thread the supplied band through the opening of the clamp filter to fasten the core, and then cut away any extra length of the band.

Installation location

- Measurement lead

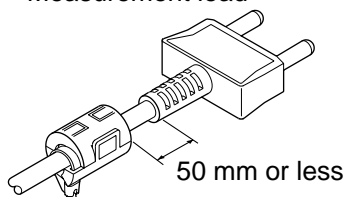

- RJC sensor connection cable

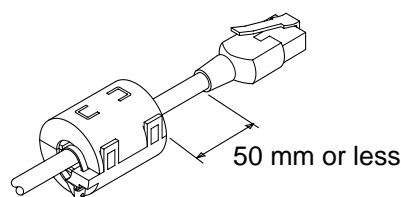

Installing Dry Cells



CAUTION

When using dry cells, observe the following precautions:

- The use of AA alkaline cells is recommended.
- When inserting a battery, observe the polarity; otherwise, a liquid spill or explosion may occur.
- Before operating the instrument, make sure that the dry cell holder is inserted into the body and the back cover is closed.
- Do not disassemble, heat, or throw a battery into a fire.
- Do not short out a cell.
- Do not charge a dry cell.
- Do not solder a line onto a dry cell.
- Use new dry cells from the same manufacturer.
- When dry cells become weak, replace all eight cells with new ones.
- If the instrument will not be used for a long time, remove the dry cells.

Installation

- 1 Make sure that the power switch on the front panel is turned off and no AC power supply kit is connected..
- 2 Remove the cover of the dry cell storage on the back of the body.
- 3 Insert the eight dry cells into the dry cell holder. Make sure that they are seated in the correct indicated direction of polarity (refer to the following diagram).
- 4 Attach the dry cell holder to the body and push the connector until it hits the bottom of the receiving side of the body (refer to the following diagram).
- 5 Reassemble the cover.

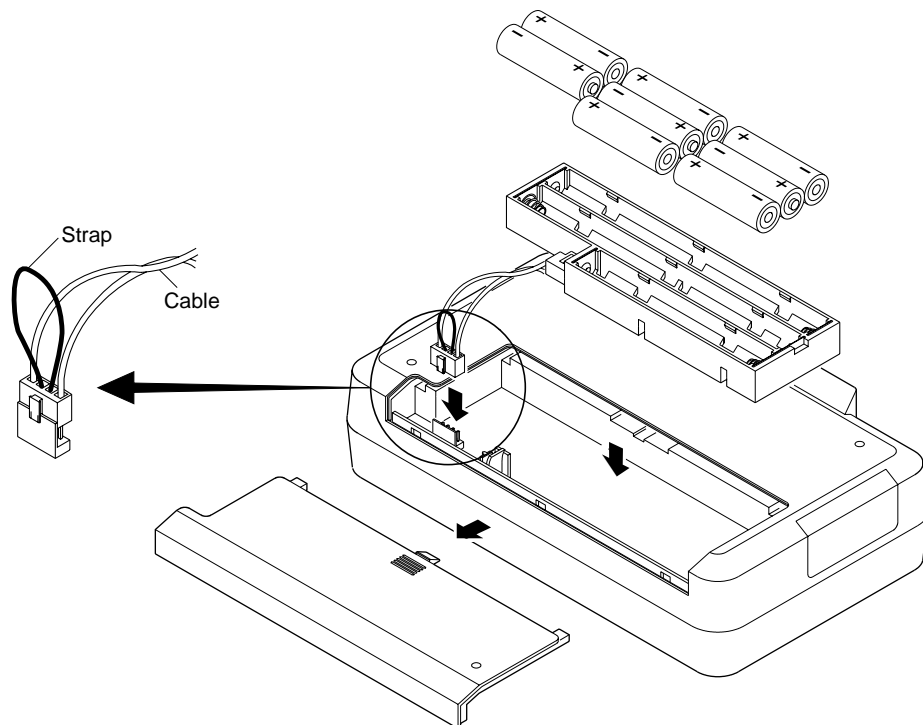

To remove dry cells, pull the strap to unplug the connector from the dry cell storage and remove the dry cell holder. Do not pull on the cable of the connector.

Low-Battery Indicator

If the dry cells become weak,  appears in the upper-left of the display. When this happens, immediately replace the old batteries with new eight alkaline batteries.

Life of Alkaline Batteries

The life of alkaline batteries varies depending on the operating conditions. Refer to the following table:

Generated Output	Measurement Function	24 V DC Power Supply	Backlight	Life (when used continuously)
20 mA (with 1 k Ω load)	on	on	on	Approx. 2 hours
5 V DC (with 500 Ω load)	on	off	off	Approx. 10 hours

Supplying AC Power (Optional)

Connecting the Power Cord

Make sure that you perform the following steps before connecting the power. Failure to do so may cause electrical shock or cause damage to the instrument.



WARNING

- Always use protective grounding to prevent electrical shock.
- Since the power cord supplied with the AC power supply kit has a 3-prong grounded plug, the AC outlet to which the power cord is to be connected must be a 3-slot grounded terminal.
- Before connecting the power cord, make sure that the power supply voltage complies with the rated electrical power voltage for the instrument.
- Before connecting the power cord, make sure that the instrument's power switch is turned off.
- Never use an extension cord that does not have protective grounding; otherwise, the protection feature will be negated.
- Do not use any AC power supply other than the power supply kit (model 366969) manufactured by YOKOGAWA.

Connecting the AC Power Supply

- 1 Make sure that the instrument's power switch is turned off.
- 2 Connect the optional AC adapter to the AC adapter jack.

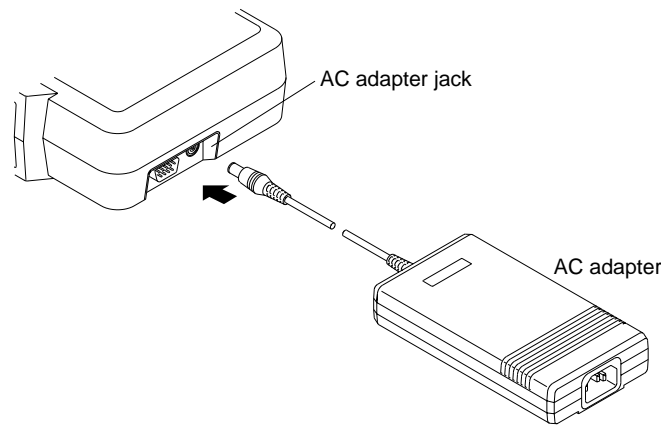

- 3 Connect the power cord included in the AC power supply kit to the AC power supply adapter.
- 4 Plug the other end of the power cord into an AC outlet that meets the following conditions. The AC outlet must be a 3-slot grounded terminal.

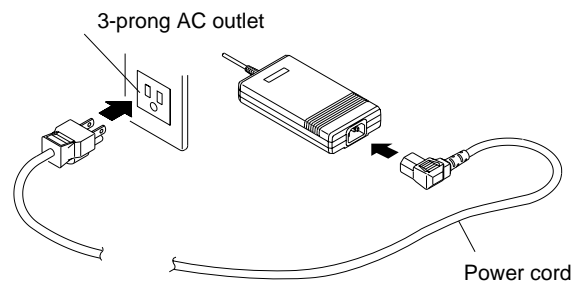

Power Rating

Rated supply voltage:	100 to 120 V AC/200 to 240 V AC
Permitted supply voltage range:	90 to 132 V AC/180 to 264 V AC
Rated supply voltage frequency:	50/60 Hz
Permitted supply voltage frequency range:	48 to 62 Hz
Maximum power consumption:	60 VA or below
Rated output voltage for AC adapter:	15 V DC
Maximum rated output current for AC adapter:	1.33 A

Attaching and Charging Optional Ni-Cd Battery Pack

Attaching the Ni-Cd Battery Pack to the Main Unit

To attach the battery pack to the instrument, follow the next procedure:



WARNING

- Before replacing the Ni-Cd battery pack, be sure to turn off the power switch on the front panel and remove the power cord from the AC outlet to avoid such possible hazards as short-circuiting in the battery-charging circuitry.
- Use only a Ni-Cd battery pack manufactured by YOKOGAWA (model: B9914PS).

- 1 Make sure that the power switch on the front panel is turned off.
- 2 Disconnect the power cord from the AC outlet.
- 3 Remove the cover of the dry cell storage compartment on the back of the body.
- 4 Insert the spacer on the cable side of the battery pack.
- 5 Insert the connector of the attached Ni-Cd battery pack until it hits the bottom of the receiving side of the body (refer to the following diagram).
- 6 Reassemble the cover.

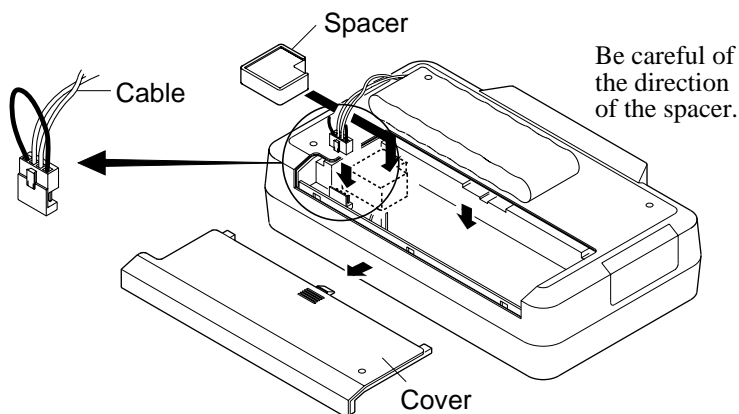

When removing the Ni-Cd battery pack, pull the strap to unplug the connector from the battery housing. Do not pull on the cable of the connector.

Precautions in Charging

- Since an optional Ni-Cd battery pack is not charged prior to shipment, fully charge the battery pack before operating the instrument for the first time.
- Before charging the battery pack, make sure that it is discharged completely. If charging is started on a battery which has not been discharged completely or on a battery for which charging has been stopped halfway through, the life of the battery pack will be reduced.
- The internal temperature of the instrument rises during charging since the internal power consumption increases. This may cause a degraded accuracy in generation or measurement compared with a normal condition. For accuracy, refer to the section, "Specifications," on page 51.
- This instrument allows charging during generation or measurement operations. In this case, keep the ambient temperature between 5 to 30°C, or the battery pack will become extremely degraded.
- If the AC power supply is interrupted during charging, the instrument waits up to about 30 minutes for restoration of the AC power supply. If the power is not restored by that time, the instrument aborts the charging sequence and automatically turns off. It resumes charging of the battery pack if the power is restored within the given time.



CAUTION

- Use only the AC power supply kit (model: 366969) manufactured by YOKOGAWA for charging.
- When charging, keep the instrument horizontal. Make sure that there is no obstruction around the instrument, so that heat generated in the instrument is properly dissipated.

Charging the Battery Pack

- 1 Supply the instrument with AC power via the method described above.
- 2 Turn on the power switch.
- 3 Press the [CHARGE] key.
"CHARGE" is displayed. The instrument then momentarily shows the remaining time every minute. The battery pack is fully charged in about 10 hours, and "CHARGE END" is displayed.
- 4 Turn off the power switch.
- 5 Disconnect the power cord and the AC adapter from the instrument.

Display Indicating Low Battery

After a certain length of operation has passed and the battery power weakens, "" appears in the upper-left of the screen. When you see this display, immediately charge the pack.

Guideline for continuous operating time

The operating time of the Ni-Cd battery pack is approximately 7.5 hours when in continuous use. Refer to the following table:

Generated Output	Measurement Function	24 V DC Power Supply	Backlight	Life (when used continuously)
20 mA (with 1 k Ω load)	on	on	on	Approx. 2.5 hr.
5 V DC (with 500 Ω load)	on	off	off	Approx. 7.5 hr.

Turning the Power Switch On and Off Before Turning On the Power

For driving this instrument, AA dry cells, an AC power supply (optional), or a Ni-Cd battery pack (optional) is available. Before turning the instrument on, prepare the intended power supply following the above instructions.

Note

Before operating the instrument using dry cells or the Ni-Cd battery pack (i.e., battery driving), disconnect the power cord and AC adapter. If the AC power source remains connected, the instrument will operate on the AC power rather than on the batteries.

Turning the Power on and off

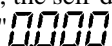

Pressing the power switch on the front panel alternates between on and off. When turning the power switch on, the self-diagnosis function runs, and "OFF" that indicates the output is turned off and " mV" appear on the lower line of the display.

Automatic Power Off

If the instrument has not received a key operation or sending/receiving request through the communication interface for approximately 30 minutes, the power supply automatically turns off. If necessary, turn the power switch back on.

Turning Backlighting On and Off

Backlighting can be turned on so that it is easy to see the screen even if generation/measurement is done in a dark place. However, this will shorten the life of the batteries when the instrument is being operated by battery.

- 1 Press the [] key.
- 2 To turn backlighting off, press the [] key again.

Note

When backlighting the instrument, the internal power consumption increases, and the internal temperature rises. This may cause a degraded accuracy in generation or measurement compared with a normal condition. For accuracy, refer to the section, "Specifications," on page 51.

Averaging, Key Type, International Temperature, Temperature Unit Settings

This instrument allows the setting of Averaging, Key Type, International Temperature, and Temperature Unit Settings from the maintenance menu.

Averaging setting: This specifies whether to enable (on) or disable (off) the moving average of the measured data. If the measured data display fluctuates due to noise, set the averaging setting to on to perform the moving averages. The setting defaults to off.

Key-type selection: Either the up/down keys (UP-DN) or numeric keypad (TEN) is available for the output value setting key. The setting defaults to "UP-DN."

International temperature standard selection: Either of IPTS68 or ITS90 is available for the international temperature standard. The setting defaults to "ITS90."

Selection of temperature unit: Either °C or °F can be selected as the temperature unit. The default setting is °C.

Setting

SP FC
End

- 1 Press the [NEXT ENTER] key and the [ZERO CLR] key at the same time. [SP FC] and [End] are displayed.

SP FC
SEt uP

- 2 Press the [▲] or [▼] key until [End] on the lower line of the display changes to [Set uP], and then press the [NEXT ENTER] key. The setup menu is displayed.

SEt uP
AVG

- 3 Pressing the [▲] or [▼] key changes the bottom menu from [AVG] to [KEY] and [tYPE]. To set the averaging function, display [AVG] and press the [NEXT ENTER] key.

AVG
on

- 4 Select [on] or [off] using [▲] or [▼] and press the [NEXT ENTER] key.

SEt uP
KEY

- 5 To specify the key type, display [KEY] using [▲] or [▼] and press the [NEXT ENTER] key.

KEY
tEn

- 6 Select [uP-dn] or [tEn] using [▲] or [▼] and press the [NEXT ENTER] key.

SEt uP
tTYPE

- 7 To set the international temperature standard, display [tTYPE] using [▲] or [▼] and press the [NEXT ENTER] key.

tTYPE
, tS90

- 8 Select the [iPtS68] or [itS90] using the [▲] or [▼] and press the [NEXT ENTER] key.

SEt uP
t unit



- 9 To set the temperature unit, display [t unit] using the [▲] or [▼] and press the [NEXT ENTER] key.

t unit
C

- 10 Select [C] or [F] using the [▲] or [▼] and press the [NEXT ENTER] key.

SP FC
SEt uP
SP FC
End

11 Press the [] to display [Set uP] on the lower line of the display.

12 Press the [] or [] to display [End] and press the [NEXT ENTER] key.
The measurement/generation screen is returned.

Generation

Connecting the Output Terminal

- 1 Insert the plug of the measurement lead into the output terminal of the instrument.
- 2 Pinch the terminals on the target device with the clips on the other side of the lead.

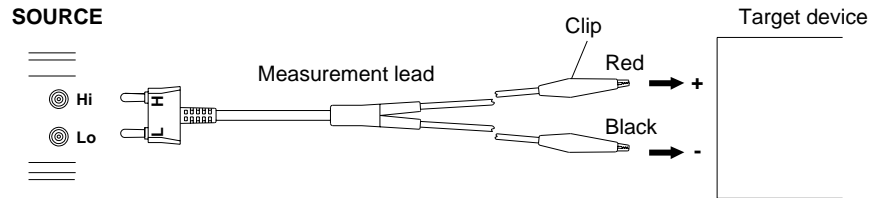

Wiring generating resistance or RTD (3-line or 4-line wiring)

The use of optional input-terminal adapters (751512) makes it easy to implement 3-line or 4-line wiring. Input-terminal adapter is an adapter for conversion from safety terminal to binding post.

Prepare wire rods in stead of the typical measuring lead and connect it as shown in the following figure (for a three-wire system).

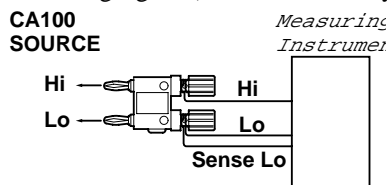

CAUTION

- Do not apply voltage to the output terminal except when the instrument is in the current-generation mode. Otherwise, the internal circuitry may be damaged.
- Since this instrument is calibrated with the voltage drop of the measurement lead excluded, an error due to the resistance at the measurement lead (approx. 0.08Ω) must be considered.

Before Generation

For accurate generation, be sure to perform auto-zero calibration (i.e., cancel the offset error) before generation.

Effects of executing auto-zero calibration

- During measurement: The displayed data of measurement are held until the auto-zero calibration ends, and sampling is also interrupted if applicable.
- When averaging is enabled: The accumulated data for a moving average is discarded, and a new averaging process starts as the auto-zero calibration ends.

- 1 Press the [FUNCTION] key on the SOURCE side until [CAL/no] is displayed.
- 2 Press the [▲] or [▼] key to change the lower display to [YeS].
- 3 Press the [NEXT ENTER] key to execute auto-zero calibration.
- 4 After completing auto-zero calibration, the function switches to DCV.

DC Voltage, DC Current, Resistance

The output terminal generates voltage, current or resistance at the specified value.

- 1 Press the [FUNCTION] key on the SOURCE side to align ◀ with the [DCV], [DCA], or [Ω] that you want.
- 2 Press the [RANGE] key on the SOURCE side to select the generation range.

Type	Generation Range	Display	Setting Range
DCV	100 mV	0000 mV	-10 to 110 mV
	1 V	000000 V	-0.1 to 1.1 V
	10 V	00000 V	-1 to 11 V
DCA	20 mA	0000 mA	0 to 22 mA
Ω	500 Ω	000 Ω	0 to 550 Ω
	5 k Ω	00000 k Ω	0 to 5.5 k Ω
	50 k Ω	0000 k Ω	0 to 55 k Ω

- 3 To change the polarity, press the [+/-] key.
Selecting "-" places a leading minus sign (-) before figures, while selecting "+" places no leading sign.
- 4 Specify the output value.
 - **Using [▲] or [▼] (for initial setting)**
Press [▲] or [▼] to specify the output value from the rightmost digit.
To reset the value to zero, press the [ZERO CLR] key.
 - **Using the numeric keypad (refer to page 21)**
Enter an output value using the numeric keypad and the decimal point key, and press the [NEXT ENTER]. The figure flickers when entering a value.
When entering decimals, press the decimal point key first and then the appropriate key or keys on the numeric keypad.
If a value out of the generation range is specified, an error occurs. In this case, press the [ZERO CLR] to reset to the previous value, and reenter a new value.
- 5 Press the [SOURCE ON] key to start generation.
[ON] is displayed.
To stop the output, press the [SOURCE ON] key again.
[OFF] is displayed.
[OFF]: Indicates that the relay on the output stage is open.

Voltage generation

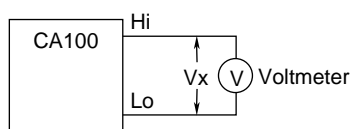

Vx: Specified voltage

Current generation

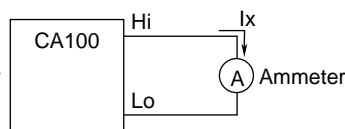

Ix: Specified current

Resistance generation

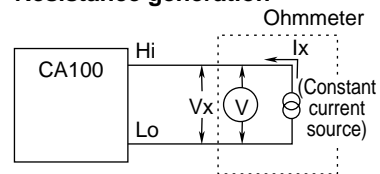

Ix: Current from the constant current source (measured current)

Rx: Specified value from this instrument

Vx: Generated voltage value represented as $I_x \cdot R_x$

* This function is unavailable for the constant voltage source.

Note

- When outputting, if you change the generation function, generation range, or polarity (only for current generation), output turns off automatically.
- The resistance generation of this instrument employs an "active impedance" scheme in order to provide a dummy resistance. This scheme generates a DC voltage appropriate for the current being measured that is supplied by a resistance meter such as a multimeter. The scheme, therefore, can generate correct DC voltages only for the resistance meter used in the measuring method shown in the figure on the previous page (i.e., the value of the supplied current being measured varies depending on the range of resistance generation. For further details, see the specifications of resistance on page 51). Note that connecting a low-impedance device (e.g., a voltage source, capacitor, or resistor) to the output during resistance generation may cause oscillation.
- In the case of the resistance generation function, it takes 10 ms in a 500 Ω range (refer to the specifications for other ranges) for the instrument-detected resistance measurement current to settle within the given accuracy range. This means that the connecting time must be no less than 10 ms where a device that operates by electrically switching its signal input circuit is used.
- Providing any different type of setting with the [ZERO CLR] and [NEXT ENTER] keys during resistance generation will abort the generation.
- Providing any different type of setting with the [ZERO CLR] and [NEXT ENTER] keys when the generation function is either TC, RTD, FRQ, or PULSE will change the function to DCV.

Output Limiter

If the load current when generating a voltage of 1 or 10 V range or the load voltage when generating a current of 20 mA range exceeds the maximum value in the specifications, the protective limiter turns output off. To recover the output, correct the load to a normal state and press the [SOURCE ON] key to turn output on.

Current sinking function

This allows drawing the specified value of the current from an external voltage source in the direction of the Hi terminal.

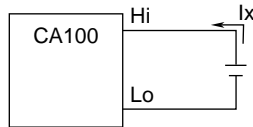

Ix: Specified value of current

To use the function follow the procedure below:

- 1 Turn off the external power supply (up to 28 V).
- 2 Connect the external power supply to the output terminal on the instrument.
- 3 Select [DCA] using the [FUNCTION] key, set the polarity to "-" using [+/-], and specify the output value.
- 4 Turn on the external power supply and press the [SOURCE ON] key to turn on output.

Note

- The current-generation function of the CA100 may result in an unstable output if the CA100 is connected to a positioner or electro-pneumatic converter having a large input inductance component. Make sure the input inductance component of the equipment to be connected is no greater than 100 μH.
- If the equipment's input inductance component is unknown, connect the CA100 to the equipment as shown below, and measure the generated current. If the reading does not stabilize or an accuracy error results at that point, the input inductance component is likely to be greater than 100μH.

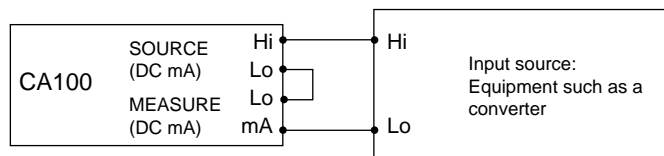

- If the equipment's input inductance component is too large, connect a 200-Ω resistor and a 1-μF capacitor to the CA100's output, as shown below. This setup makes it possible to connect an input having an inductance component of up to 3 H to the CA100. (This RC circuitry is available as an accessory part numbered 990 20.)

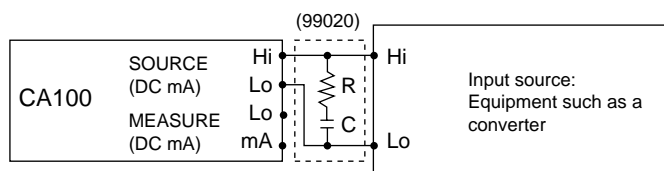

R: 200 Ω \pm 10%, 1/4 W
 C: 1 μ F \pm 10%, 50 V
 (Equivalent to the 533M5002105K resistor from Matsuo Electric)

Note however that this additional circuitry reevaluates the CA100's response specification as noted below.

Response: 1 sec (at load resistances no greater than 2 k Ω)

Do not use this circuitry for purposes other than current generation; otherwise, it can produce measurement errors.

Thermocouple, Resistance Temperature Detector

This generates thermo-electric power corresponding to the temperature of thermocouple (TC) or resistance corresponding to the temperature of resistance temperature detector (RTD) from the output terminal.

- 1 Press [FUNCTION] on the SOURCE side and align ◀ to [TC] or [RTD].
- 2 Press [RANGE] on the SOURCE side to select TC type.

Type	TC/RTD Type	Display	Temperature Range
TC	K	00 °C	-200.0 to +1372.0°C
	E	00 °C	-250.0 to +1000.0°C
	J	00 °C	-210.0 to +1200.0°C
	T	00 °C	-250.0 to +400.0°C
	N	00 °C	-200.0 to +1300.0°C
	B	400 °C	+400 to +1820°C
	R	0 °C	-40 to +1767°C
	RTD	Pt100	00 °C

* RTD : The specifications are compatible with both IEC 751-1983 and IEC 751-1995.
 TC : The specifications are compatible with both IEC 584-1-1989 and IEC 584-1-1995.
 To switch the standard, refer to page 21.

- 3 To change the polarity, press the [+/-] key.
 Selecting "-" places a leading minus sign (-) before figures, while selecting "+" places no leading sign.
- 4 Specify the temperature.
 - **Using [▲] or [▼] (for initial setting)**
 Press [▲] or [▼] to specify the output value from the rightmost digit.
 To reset the value to zero, press the [ZERO CLR] key.
 - **Using the numeric keypad (refer to page 21)**
 Enter a temperature value using the numeric keypad and the decimal point key (where applicable), and press the [NEXT ENTER] key. The figure flickers when entering a value.
 When entering decimals, press the decimal point key first and then the appropriate key or keys on the numeric keypad.
 If a value out of the generation range is specified, an error occurs. In this case, press [ZERO CLR] to reset to the previous value, and reenter a new value.
- 5 Press the [SOURCE ON] key to start generation.
 [ON] is displayed.
 To stop the output, press [SOURCE ON] again.
 [OFF] is displayed.

Note

- When outputting, if you change the generation function or generation range, output turns off automatically.
- The generation of RTD-use signals in this instrument employs an "active impedance" scheme in order to provide a dummy resistance. This scheme generates a DC voltage appropriate for the current being measured that is supplied by a resistance meter such as a multimeter. The scheme, therefore, can generate correct DC voltages only when the value of the supplied current being measured is 1 to 5 mA. Note that connecting a low-impedance device (e.g., a voltage source, capacitor, or resistor) to the output during resistance generation may cause oscillation.
- In the case of generating RTD-use signals, it takes 10 ms in a 500-Ω range (refer to the specifications for other ranges) for the instrument-detected resistance measurement current to settle within the given accuracy range. This means that the connecting time must be no less than 10 ms where a device that operates by electrically switching its signal input circuit is used.

Reference Junction Compensation

Use a reference junction compensation (RJC) sensor (optional) to calibrate a thermometer containing built-in RJC without using an external 0°C reference junction chamber.

- 1 Connect an RJC sensor to the RJC sensor input connector.
When connecting, insert the connector until its upper locking hook snaps into place. To disconnect the connector, press the hook lightly down to release the lock and pull it.

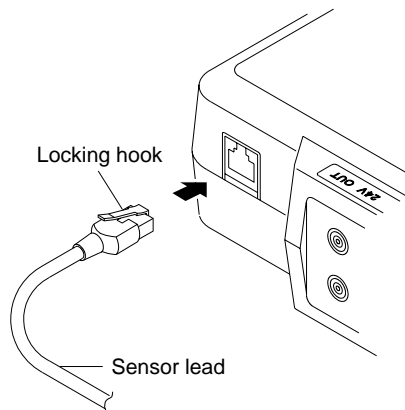

Note

- Do not pull the sensor lead with the connector locked.

- 2 Connecting the sensor automatically activates the INT RJC state and thermo-electric power is output with reference to the temperature detected by the RJC sensor. [INT RJC] is displayed at this time. (For reference temperature measurement accuracy using an RJC sensor, refer to the section "Specifications" on page 52.)

- The thermo-electric power when an RJC sensor is connected can be achieved by subtracting the thermo-electric power detected by an RJC sensor from the thermo-electric power without an RJC sensor.

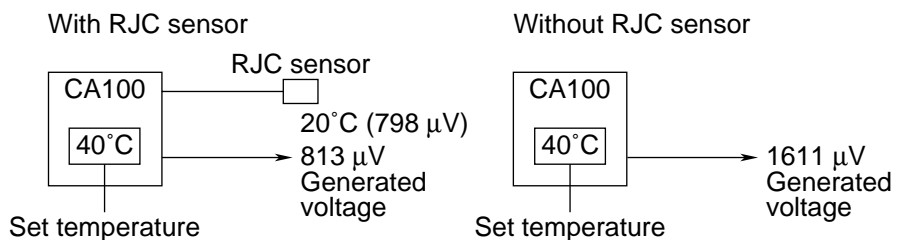

- Compensating the output voltage using the temperature detected with the RJC sensor is executed on a sampling rate of approximately 10-second intervals. It means that there is a delay of up to 10 seconds before the first compensation starts.
- To perform accurate measurement, leave the instrument for a certain time (5 min. at room temperature) before starting the measurement.



CAUTION

Be sure to disconnect the RJC sensor from the instrument when no reference junction compensation is required.

Frequency, Pulse Signal

This generates frequencies and pulse signals at specified values via the output terminal.

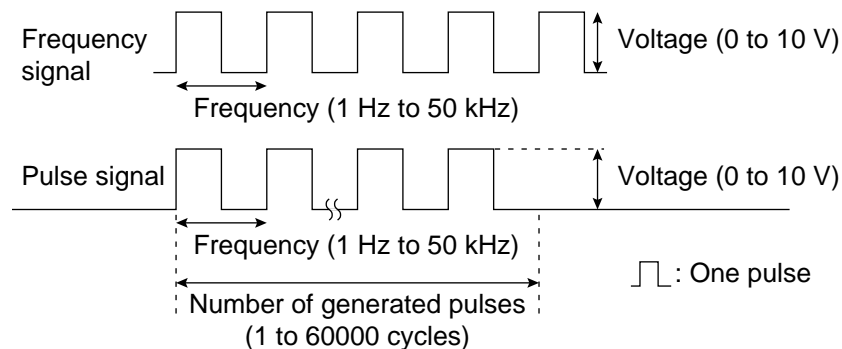

- 1 To generate frequencies, press [FUNCTION] on the SOURCE side to align ◀ with [FRQ]. [Hz] is displayed. Jump to step 4.
To generate pulse signals, align ◀ with [PULSE]. [CYCLES] appears. Go to step 2.
- 2 Specify the number of pulses to generate between 1 and 60,000.
 - **Using [▲] or [▼] (for initial setting)**
Press [▲] or [▼] to specify the number of pulses to be output.
To reset the value to zero, press [ZERO CLR].
 - **Using the numeric keypad (refer to page 21)**
Enter the number of pulses to generate using the numeric keypad, and press the [NEXT ENTER] key. The figure flickers when entering a value. If a value out of the range of 1 to 60,000 is specified, an error occurs. In this case, press [ZERO CLR] to reset to the previous value, and reenter a new value.
- 3 Press [NEXT ENTER].
[Hz] is displayed.
- 4 Press [RANGE] on the SOURCE side to select the voltage frequency range.

Type	Frequency Range	Display	Setting Range
FRQ/ PULSE	100 Hz	Hz	1.0 to 110.0 Hz
	1000 Hz	Hz	90 to 1100 Hz
	10 kHz	kHz	0.9 to 11.0 kHz
	50 kHz	kHz	9 to 50 kHz

-
- 5 Specify the voltage frequency to generate.
 - **Using [▲] or [▼]**

Press [▲] or [▼] to specify the voltage frequency to generate from the rightmost digit. To reset the value to zero, press [ZERO CLR].
 - **Using the numeric keypad**

Enter a voltage frequency to generate using the numeric keypad and the decimal point key (if applicable), and press the [NEXT ENTER] key. The figure flickers when entering a value.

When entering decimals, press the decimal point key first and then the appropriate key or keys on the numeric keypad.

If a value out of the voltage frequency range is specified, an error occurs. In this case, press [ZERO CLR] to reset to the previous value, and reenter a new value.
 - 6 Press [NEXT ENTER].

00000 V is displayed.
 - 7 Specify a voltage to generate between 0 and 10 V.
 - **Using [▲] or [▼]**

Press [▲] or [▼] to specify the voltage to generate from the rightmost digit. To reset the value to zero, press [ZERO CLR].
 - **Using the numeric keypad**

Enter a voltage generated using the numeric keypad and the decimal point key, and press the [NEXT ENTER] key. The figure flickers when entering a value.

When entering decimals, press the decimal point key first and then the appropriate key or keys on the numeric keypad.

If a value out of the 10 V range is specified, an error occurs. In this case, press [ZERO CLR] to reset to the previous value, and reenter a new value.
 - 8 Press the [SOURCE ON] key to start generation.

[ON] is displayed.

To stop the generation, press [SOURCE ON] again.

[OFF] is displayed.

Note

- When outputting, if you change the generation function or generation range, output turns off automatically.
-

Measurement

Connecting the Input Terminal Connection Precautions



WARNING

- To prevent electrical shock, a protective grounding connection must be made before connecting the measurement lead.
- Always turn off the power supply to the object being measured before connecting it to the instrument. Never connect or disconnect the measurement lead wires from the object while power is being supplied to it; otherwise, a serious accident may result.
- Make sure that you do not connect a current circuit to the voltage input terminal or vice versa. An incorrect connection may cause damage not only to the circuit or equipment under test and to this instrument, but may also injure the operator.
- Be sure to use the attached measuring lead.
- The maximum allowable potential difference is 42 V_{peak} and Cat II for every I/O and ground terminal. However, the maximum allowable potential difference between the negative 24 V OUT terminal and the ground is 18 V_{peak}. Never apply a voltage exceeding this tolerance, or else the measured target circuit or equipment may be damaged and the operator injured.



CAUTION

- Do not apply a voltage exceeding the permitted maximum input voltage, or else the instrument may be damaged.
Permitted maximum input voltage: 42 V DC
- Do not apply a current exceeding the permitted maximum input current, or the built-in current input circuit's protective fuse may burn out. If it does, replace the fuse with a new one. For replacing fuses, refer to page 50.
Permitted maximum input current: 120 mA DC

Connecting

- 1 Insert the plug of the measurement lead to the input terminal of the instrument.
- 2 Pinch the output terminals on the target device with the clips on the other side of the lead.

For measuring DC voltage or resistance

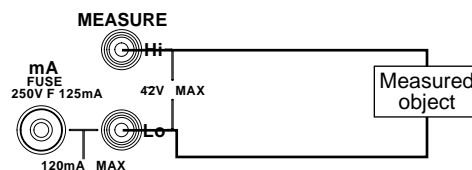

For measuring DC current

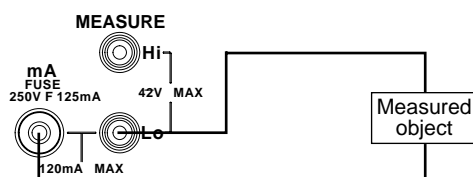

Measuring the DC Voltage, DC Current, and Resistance

- 1 Press the [MEASURE ON] key.
- 2 Press the [FUNCTION] key on the MEASURE side to align ► with the [DCV], [DCA], or [Ω] that you want.
- 3 Press the [RANGE] key on the MEASURE side to select the measuring range.

Type	Measuring Range	Display
DCV	35 V	0000 V
	5 V	00000 V
	500 mV	000 mV
DCA	100 mA	000 mA
	20 mA	0000 mA
Ω	50 k Ω	0000 k Ω
	5 k Ω	00000 k Ω
	500 Ω	000 Ω

The measured result is displayed. The displayed value is updated every second.

Note

- Any data value being measured that exceeds the 120% of the measuring range will result in overrange. The display then indicates [-OL-] (the position of the decimal point depends on the range used).
- If no measured data are present immediately after the MEASURE key is turned on or if the measurement function or range is switched to change the data on the display, the reading changes to [- - - -].
- When you switch the MEASURE key from the off to on, the instrument begins measurement with the settings given immediately before the key was turned off.
- Providing any different type of setting with the [ZERO CLR] and [NEXT ENTER] keys during measurement will abort measurement.

Display Holding On and Off

This determines whether the updating of displayed measured data is halted.

- 1 Press the [HOLD] key. "HOLD" is displayed.
- 2 To disable the display holding, press [HOLD] again. "HOLD" disappears from the display.

Note

- The "HOLD" state only stops the updating of the display, but allows the instrument to continue sampling data. This means that the measured data are updated through the communication interface even during the "HOLD" state.
- Holding the display is not allowed if the communication mode is "talk-only" or the "printer" mode. (See page 39.)

24 V DC Power Supply

Connecting the Output Terminal Connection Precautions



WARNING

The permitted maximum potential difference is 42 V_{peak} and Cat II for every I/O and earth terminal. However, the permitted maximum potential difference between the negative 24 V OUT terminal and the ground is 18 V_{peak}. Never apply a voltage exceeding this tolerance, or the measured object circuit or equipment may be damaged and the operator injured.



CAUTION

- Do not apply a voltage to the 24 V DC output terminal externally, or else the instrument may be damaged.
- If the 24 V DC output terminal is short-circuited or the load current exceeds the range (24 to 30 mA), an error is displayed and the 24 V DC power supply is turned off. In this case, remove the cause of the short circuit or the overload completely and then turn the 24 V DC power supply back on. Note that an overload cannot be detected for the first 5 seconds or so after turning on the 24 V DC power supply.
- When using batteries, continuous running of the instrument with the load current of the 24 V DC power supply at more than 20 mA shortens the operable time extremely.

Connecting

- 1 Insert the plug of the measurement lead into the 24 V DC output terminal of the instrument.
- 2 Pinch the 24 V DC terminals on the target device with the clips on the other side of the lead.

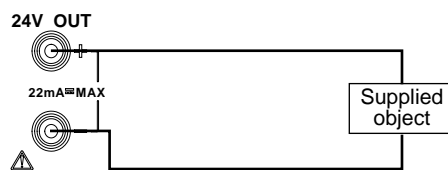

Turning Output On and Off

- 1 Press the [24 V OUT].
[24 V OUT] appears on the screen and the 24 V DC power is supplied from the output terminal.
- 2 To stop the 24 V DC power supply, press [24 V OUT] again.
[24 V OUT] disappears from the display.

Note

- If the 24 V DC power supply becomes overloaded, the power supply turns off automatically. To continue supplying 24 V DC power, remove the cause of the overload and then press the [24 V OUT] key again.

Using the RS-232-C Interface

RS-232-C Interface Functions

Reception Function

Allows you to make the same settings (except for on and off of the power supply and those related to communication) as those which can be made using the keys on the front panel. This function allows the instrument to receive a request for the output of a generated set-up value, measured value, panel set-up information and error codes.

Transmission Function

Allows the instrument to output a generated set-up value and measured value at a specified cycle. The panel set-up information and status byte can also be output. In addition, error codes which occurred can be output.

Note

- During the talk-only or printer mode (when the printer is connected), only output of the generated set-up value and measured value at a specified cycle is available.
- When using any source other than an AC power supply, the power supply to the circuit for the RS-232-C is turned off to increase the operating time available with batteries or the like. Turn on the power supply as necessary. (See page 37.)

Specifications



WARNIN

When connecting the RS-232-C cable to the connector, make sure the power switch of the instrument is turned OFF. Connect the RS-232-C connector to the remote instrument with the cable before starting the RS-232-C communication.

Electrical characteristics: Conforms to EIA RS-232-C.

Connection:	Point-to-point
Communications:	Full-duplex
Synchronization:	Start-stop system
Baud Rate:	150, 300, 600, 1200, 2400, 4800 and 9600
Start Bit:	1 bit (fixed)
Data Length:	7 or 8 bits
Parity:	Even, odd or no parity
Stop Bit:	1 or 2 bits
Connector:	DELC-J9PAF-13L6 (JAE or equivalent)
Hardware Handshaking:	User can select whether RS and CS signals will always be true, or be used for control.
Software Handshaking:	User can select whether to control only transmission or both transmission and reception using X-on and X-off signals. X-on (ASCII 11H) X-off (ASCII 13H)
Receiver Buffer Size:	256 bytes

Connecting the RS-232-C Interface Cable

When connecting this instrument to a personal computer, make sure that the handshaking, transmission rate and data format selected for the instrument match those selected for the computer. For details, refer to the following pages. Use an interface cable that is shielded and meets the instrument's specifications requirements.

Connectors and Signals

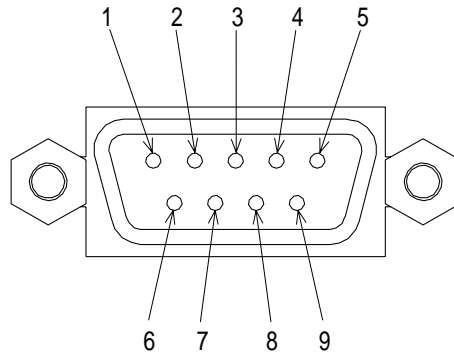

RS-232-C connector: DELC-J9PAF-13L6 or equivalent

Note: The instrument side is provided with a male D-Sub 9 pin.

- 2 RD (Received Data): Data received from personal computer
Signal direction: Input
- 3 SD (Send Data): Data transmitted to personal computer
Signal direction: Output
- 5 SG (Signal Ground): Ground for signals
- 7 RS (Request to Send): Signal used to handshake when receiving data from personal computer
Signal direction: Output
- 8 CS (Clear to Send): Signal used to handshake when transmitting data from personal computer
Signal direction: Input

Pins 1, 4, 6, and 9 are not used. Make sure, however, that pin 1 (Frame Ground) of the counterpart is grounded.

Signal Direction

The figure below shows the direction of signals used by the RS-232-C interface.

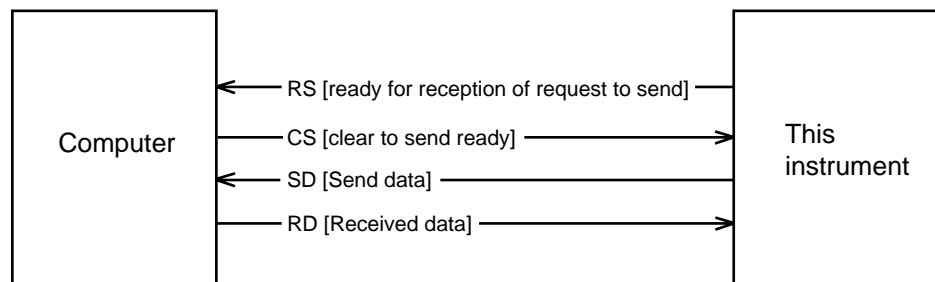

RS-232-C Standard Signals and their JIS and CCITT Abbreviations

RS-232-C Standard Signals

Signals

Pin No.		Abbreviation			Name
Pin 9 connector	Pin 25 connector	RS-232-C	CCITT	JIS	
5	7	AB (GND)	102	SG	Ground for signal
3	2	BA (TXD)	103	SD	Send data
2	3	BB (RXD)	104	RD	Received data
7	4	CA (RTS)	105	RS	Request to send
8	5	CB (CTS)	106	CS	Clear to send

Notice on Connecting Printers

- Printers which support ESC/P commands can be used.
- When connecting a printer, refer to the printer specifications to ensure that a properly-wired shielded cable is used.
- For details on the cable's pin assignments for connection to the CA100 calibrator, refer to this information for an RS-232-C connector.
- Configure the baud rate, handshaking, and so on correctly, according to the specifications of the printer being used.

Settings for Communication

The maintenance menu ([ZERO CLR] + [NEXT ENTER] keys) allows the setting of communications functions.

Settings

Power source for communication

Turns the power supply to communications functions on and off. If this is disabled, no communications function is available.

Communications modes

The following communications modes are available.

If the instrument continues providing output for more than two to three hours, it will start delivering signals at an interval approximately one second longer than the preset interval because of the characteristics of the internal clock.

Communication mode	Description
Normal mode (nor)	Allows operating normal communication functions.
Talk-only mode (tonLY)	Outputs set generation value and measured value at specified interval (0* to 3,600 sec.).
Printer mode (Print)	Outputs set generation value and measured value at specified interval (0* to 3,600 sec.) via a printer.

* If 0 is specified for the interval, one data item is output whenever the [HOLD] key is pressed.

Handshaking

To use an RS-232-C interface to transfer data between this instrument and a computer, it is necessary to use certain procedures by mutual agreement to ensure the transfer of data. These procedures are called "handshaking."

Various handshaking systems are available depending on the computers to be used; the same handshaking system must be used for both the computer and this instrument.

There are four handshaking system combinations in this CA100 calibrator.

Handshaking System Combination (A circle indicates that the function is available.)

Handshake mode selection number	Data send control (Control method when sending data to computer)			Data receiving control (Control method when receiving data from computer)		
	Software handshaking	Hardware handshaking	No handshaking	Software handshaking	Hardware handshaking	No handshaking
	Sending stops when X-OFF is received, and sending is resumed when X-on is received.	Sending stops when CB (CTS) is false, and sending is resumed when CB is true.		X-OFF is sent when the received data buffer becomes three quarters full, and X-on is sent when the received data buffer becomes one quarter full.	CA (RTS) is set to false when the received buffer becomes three quarters full, and is set to true when the received data buffer becomes one quarter full.	
0			○			○
1	○			○		
2	○				○	
3		○			○	

Note

- The program for the personal computer must be designed in such a way that the receive buffers of both this instrument and the personal computer never become full.

Precautions Regarding Data Receiving Control

When handshaking is used to control received data, data may still be sent from the computer even if the free space in the receive buffer drops below 64 bytes. In this case, after the received buffer is full, the excess data will be discarded, whether handshaking is in use or not. Data storage to the buffer will begin again when there is free space in the buffer.

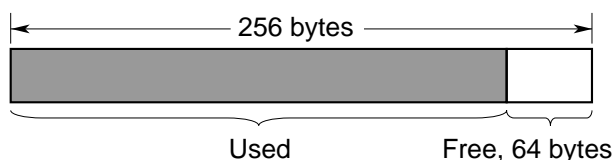

When handshaking is in use, reception of data will stop when the free space in the buffer drops to 64 bytes since data cannot be passed to the main program fast enough to keep up with transmission.

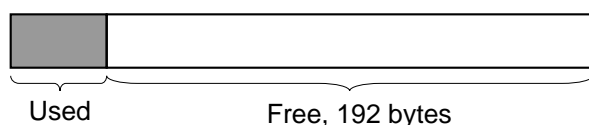

After the reception of data stops, data continue to be passed to the internal program. Reception of data starts again when the free space in the buffer increases to 192 bytes.



Whether handshaking is in use or not, if the buffer becomes full, any additional received data are no longer stored and are discarded.

Data Receiving Control in Handshaking Mode

Setting Data Format

The RS-232-C interface of this instrument performs communications using start-stop synchronization. In start-stop synchronization, one character at a time is transmitted. Each character consists of a start bit, data bits, parity bit, and stop bit. (Refer to the figure below.)

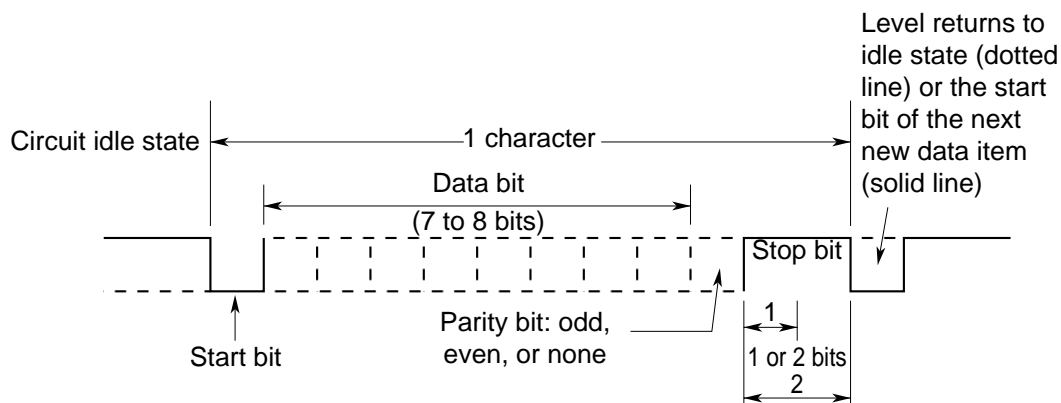

The table below shows the data format combinations supported by this instrument.

Setting	Start bit	Data length	Parity	Stop Bit
0	1	8	No	1
1	1	7	Odd	1
2	1	7	Even	1
3	1	7	No	2

Selecting the Baud Rate

The following baud rates can be selected.
150, 300, 600, 1200, 2400, 4800, 9600

Selecting the Terminator

The following terminators can be selected.
CR+LF, LF, CR

Setting

SP FC
End

SP FC
Com

Com
on

mode
nor

SEC
120

Hand
0

For
0

brAtE
9600

dEL, n
CrLF

SP FC
Com

SP FC
End

- 1 Press the [NEXT ENTER] key with the [ZERO CLR] key pressed. [SP FC] and [End] are displayed.
- 2 Press [▲] or [▼] until [End] on the lower line of the display changes to [Com], and then press the [NEXT ENTER] key. The communication menu appears.
- 3 Press [▲] or [▼] to turn the communication power supply from [oFF] to [on], and press the [NEXT ENTER] key. Selecting [oFF] disables the communication function to be set.
- 4 Select a communication mode using [▲] or [▼] and press [NEXT ENTER].
- 5 If the Normal mode is selected, jump to step 6. If the talk-only mode or printer mode is selected, specify a cycle between 0 to 3,600 seconds using [▲] or [▼] and press [NEXT ENTER].
- 6 Select handshaking using [▲] or [▼] and press [NEXT ENTER] (see page 36).
- 7 Select the data format using [▲] or [▼] and press [NEXT ENTER] (see page 37).
- 8 Select the baud rate using [▲] or [▼] and press [NEXT ENTER].
- 9 Select the terminator using [▲] or [▼] and press [NEXT ENTER].

The settings related to communication have been completed. The display returns to the initial setting communication menu.
- 10 Display "End" using [▲] or [▼] and press [NEXT ENTER]. This returns to the measurement/generation screen.

Before Programming

Before Programming Format

The following shows the structure of program data.

Command + Parameter + Terminator

ASCII codes are used.

Example	SF	1	CRLF
	Command	Parameter	Terminator

Command

Predefined string of 1 to 3 capital letters

Parameter

Numeric values or character string (ASCII code)

Terminator

Either "CR + LF," "LF," or "CR"

Precautions when Programming

A single line can contain multiple commands. In this case, make sure that command statements (a command + parameters) are separated by semicolons (;).

Note

- A space (or tab) between a command and parameter can be omitted.
- Command statement lines must not exceed 50 characters. Anything after 50 will be truncated.

Sample Program

Operating environment of sample programs:

Computer

IBM PC/AT and compatible system

Software

Quick Basic version 4.0/4.5

Sample programs demonstrating the commands are given in the Appendix. Refer to page App-7.

Using Talk-Only or Printer Mode

To start output while in the talk-only or printer mode, press the [HOLD] key. The set generation values and measured values are output at the cycle predefined in the communications menu. During output, the character string "HOLD" blinks on the display. For examples of output, see the section "Output Format for Talk-Only Mode and Printer Mode" on page App-6.

To stop outputting, press the [HOLD] key again.

Note

- In the Printer mode, the SEIKO EPSON ESC/P command support printer is available. Be sure to match the baud rate, handshaking, and data format between the instrument and printer.

Troubleshooting

Items to be Checked in the Case of an Abnormality

If the instrument does not operate properly even if the actions given in the table below are performed, if "Servicing required" appears as a corrective action, or if there are any other problems, contact your nearest Yokogawa representative as listed on the back cover of this manual.

Symptom	What to Check	Reference Pages
Nothing is displayed when the power is turned on.	<ul style="list-style-type: none"> Is the connector of the battery holder or battery pack connected securely? Is the battery weak? Is the plug of the power cord connected securely to the power supply connector of the instrument? Is the plug on the other end connected to the AC outlet securely? Is the load condition of generation section within the specifications of the CA100? 	16, 18 17, 20 17
Measured data or generated source is odd.	<ul style="list-style-type: none"> Is it possible that the data are skewed because of noise? Is the measuring lead connected correctly? Are the ambient temperature and humidity within the allowed range? 	15, 23, 25, 30
Instrument cannot be configured or controlled via the RS-232-C interface.	<ul style="list-style-type: none"> Are the instrument and controller using the same communication settings? Are the connectors connected correctly? 	33 to 35

Error Codes and Corrective Actions

Error Code	Description	Corrective Action	Reference Pages
11	Received command not used in this instrument	Check for error in the command sent.	47, App-1
12	Specified parameter value is outside allowed range.	Correct the value.	47, App-1
13	Attempt made to execute a command that is not permitted in a certain status of the instrument.	Check the status.	47, App-1
14	AC power supply is not connected.	Connect the AC power supply.	17
15	There are no Ni-Cd batteries.	Install Ni-Cd batteries.	18
16	An error was received during calibration.	Correct the output or input value from the reference equipment within the recommended value range.	46
17	The temperature range exceeds that applicable to reference junction compensation.	Set the temperature range to one applicable to compensation.	52
20	Loop power supply error	Check the load.	-
23	An output value is generated in overcurrent or over-voltage.	Check the load.	25
60	EEPROM error (set value)	Servicing required.	-
61	EEPROM error (measurement adjust value)	Servicing required.	-
62	EEPROM error (generation adjust value)	Servicing required.	-
79	ROM error	Servicing required.	-
80	RAM error	Servicing required.	-
90	Overrun error	Correct the baud rate or handshaking.	36, 39
91	Unable to output in talk-only mode or printer mode.	Turn on the power source for communication.	35, 38, 39

Maintenance

Calibration

To maintain high accuracy, the instrument should be calibrated once every year. Calibration services are also available from your nearest Yokogawa representative as listed on the back cover of this manual. The following example of calibration using the standard equipment recommended in the section "Selecting the Standards" is described.

Selecting the Standards

Generation Function

Item to be calibrated	Standard	Calibration Range	Measurement Range	Accuracy	Remarks
DCV	Digital multimeter	100 mV 1 V 10 V	Max. 110 mV Max. 1.1 V Max. 11 V	$\pm(10 \text{ ppm}+1 \mu\text{V})$ $\pm(10 \text{ ppm}+5 \mu\text{V})$ $\pm(10 \text{ ppm}+50 \mu\text{V})$	1281 (YOKOGAWA) or equivalent
DCA	Digital multimeter	20 mA	22 mA	$\pm(50 \text{ ppm}+0.4 \mu\text{A})$	1281 (YOKOGAWA) or equivalent
Ω	Digital multimeter	500 Ω 5 k Ω 50 k Ω	Max. 3 V	$\pm(10 \text{ ppm}+1 \text{ mV})$	Range of generated current 50 μA $\pm(25 \text{ ppm}+0.2 \text{ mA})$ 0.5 mA $\pm(25 \text{ ppm}+2 \text{ mA})$ 5 mA $\pm(25 \text{ ppm}+2 \text{ mA})$ 1281, 4808 (YOKOGAWA) or equivalent

Measurement Function

Item to be calibrated	Standard	Calibration Range	Generation Range	Accuracy	Remarks
DCV	Standard DC voltage generator	500 mV 5 V 35 V	500 mV 5 V 35 V	$\pm(20 \text{ ppm}+5 \mu\text{V})$ $\pm(20 \text{ ppm}+50 \mu\text{V})$ $\pm(20 \text{ ppm}+300 \mu\text{V})$	4808 (YOKOGAWA) or equivalent
DCA	Standard DC current generator	20 mA 100 mA	20 mA 100 mA	$\pm(60 \text{ ppm}+0.4 \mu\text{A})$ $\pm(40 \text{ ppm}+1 \mu\text{A})$	4808 (YOKOGAWA) or equivalent
Ω	Precision-resistance digital multimeter	500 Ω 5 k Ω 50 k Ω	500 Ω 5 k Ω 50 k Ω	$\pm 50 \text{ ppm}(5 \text{ ppm}/^\circ\text{C})$	1281 precision-resistance (Yokogawa-supplied DMM for monitoring resistance values) or equivalent

Required Environment during Calibration

Ambient temperature: $23 \pm 1^\circ\text{C}$
 Relative humidity: 45% to 75% RH
 Power supply voltage: $100 \text{ V} \pm 5\%$
 Power supply frequency: $(50/60 \text{ Hz}) \pm 1 \text{ Hz}$
 Warm-up time: Before starting calibration, the standard equipment must be warmed up for the specified time, and the instrument must be warmed up for at least 4 hours.

Point to Note during Calibration

Make sure that the AC outlet to which this instrument is to be connected is a 3-slot outlet with a grounding terminal.

Check Before Calibrating the Resistance Generation Function

Generate the one of the appropriate resistance values listed in the following table from the instrument, and measure the output voltage using a DMM. If the measured value deviates from the tolerance, calibration is unavailable when generating resistance. Contact your nearest Yokogawa representative as listed on the back cover of this manual.

Range	Generated Resistance	Tolerance
500 Ω	0.00 Ω	$\pm 20 \mu\text{V}$ or less
5 k Ω	0.0000 k Ω	$\pm 20 \mu\text{V}$ or less
50 k Ω	0.000 k Ω	$\pm 200 \mu\text{V}$ or less

Wiring

Calibrated instrument

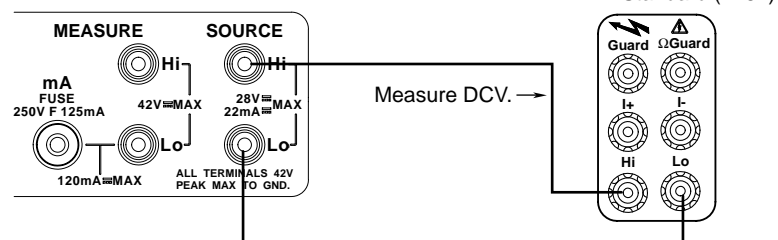

CAUTION

- Do not apply a voltage exceeding the maximum input voltage; otherwise, the input part may be damaged.
- Do not short-circuit or apply an external voltage to output terminals of the instrument or standard equipment, or else their internal circuitry may be damaged.

Calibrating the Generation Function

Wiring

DCV

Calibrated instrument

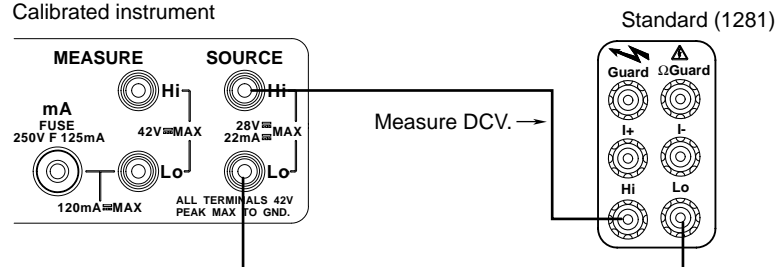

DCA

Calibrated instrument

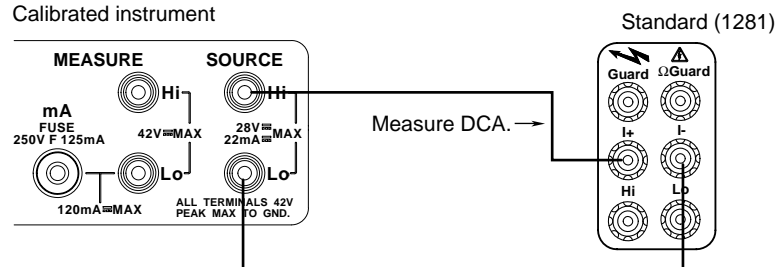

Resistance

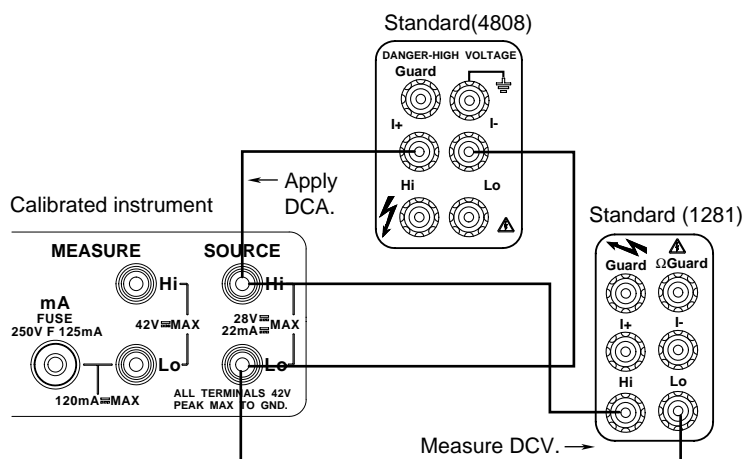

Procedure

- 1 Before turning on the instrument, connect it and the standard equipment.
- 2 Warm up the instrument and standard equipment.
- 3 Press the [NEXT ENTER] key with the [ZERO CLR] key pressed. "SP FC" and "End" are displayed.

SP FC
End

- 4 Press [▲] or [▼] until "End" on the lower line changes to "SourCE."

SP FC
SourCE

- 5 Press [NEXT ENTER] to display the calibration screen for generation.

- 6 Select one of the generation functions (DCV, DCA, Ω) using the [FUNCTION] key and press [RANGE] to select the range to calibrate (see page 24). Since each range is calibrated for two points, "FS" and "0" (for resistance, 4 points), 2 values (4 for resistance) must be output from this instrument. The recommended value for the "FS" calibration point appears at the lower line of the display first.

Value recommended for the selected range

FS
100000 mV

For DCV or DCA

- 7 Press the [SOURCE ON] key to output the value from the instrument.
- 8 Read the output value from the instrument displayed on the standard equipment (DMM), and then input the value into the instrument, and press [NEXT ENTER] to confirm it.

Value recommended for "0" calibration point

FS
96023 mV

- 9 Press [24V OUT] to toggle the function from "FS" to "0," and repeat step 8 for the remaining calibration point referring to the recommended value shown on the lower line.

Enter the reading given by the standard

0
0000 mV

- 10 Press the [HOLD] key to write the calibrated value to the EEPROM of the instrument. Perform this operation for each range.

- 11 Repeat steps 6 to 10 for each range.

For Ω (Be sure to make a check of the resistance generation function before calibration.)

- 7 Press [SOURCE ON] to output the value from the instrument. Feed the recommended current (see page 46) from the standard equipment (generator).

Value recommended for the selected range

R1 FS
500000 Ω

- 8 Read the output voltage from the instrument displayed on the standard equipment (DMM), and then calculate V/I . Input the calculated result into the instrument, and press the [NEXT ENTER] key to confirm it. To improve the accuracy of calculation, it is recommended that you use a DMM to measure the current generated by the standard equipment.

Enter the calculated resistance value

R1 FS
490036 Ω

- 9 Press [24V OUT] to switch the function from "FS" to one of the remaining adjustment points, "0," "-0," or "-FS," and repeat step 8 for each of them referring to the recommended value shown on the lower line.

R1 0
0000 Ω

- 10 Press the [HOLD] key to write the calibrated value to the EEPROM of the instrument. Perform this operation for each range.
- 11 Repeat steps 6 to 10 for each range.

Returning to the Measurement/Generation screen

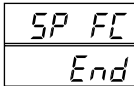

- 12 Press [*] to display [SP FC].
Press [▲] or [▼] until [End] appears on the lower line of the display.
- 13 Press the [NEXT ENTER] key to return to the Measurement/Generation screen.

Note

- For resistance calibration, a correction is made on the value averaged from the standard current fed in the normal and the reverse directions, that is, calibration points in the plus (+) and minus (-) directions are required; thus calibration is performed with 4 points.
- If you turn off the power before pressing the [HOLD] key, the set value is not stored.
- The calibrated value is retained even after turning off the power.

Calibrating the Measurement Function

Wiring
DCV

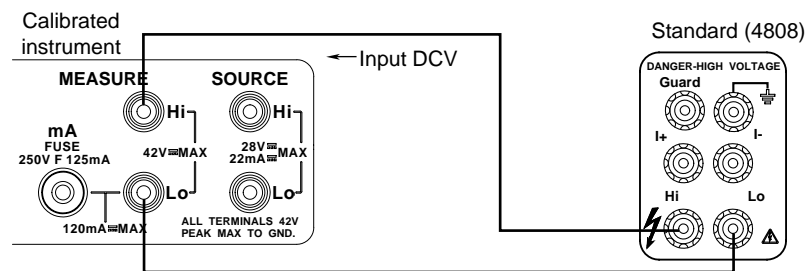

DCA

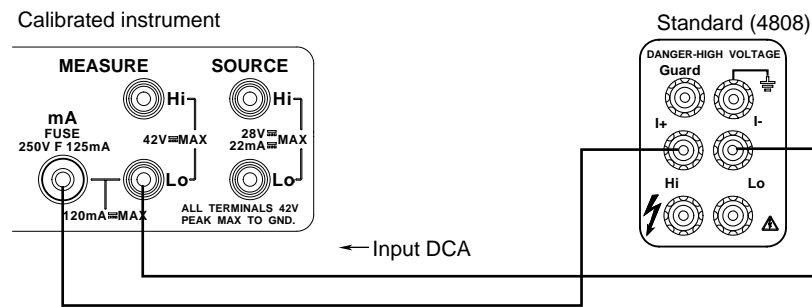

Resistance

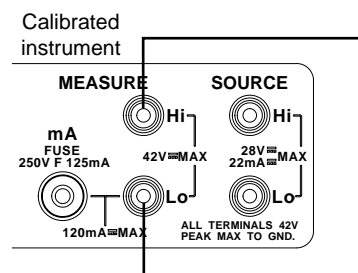

Calibration point "0"

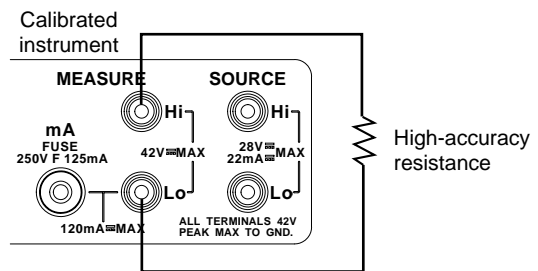

Calibration point "FS"

Procedure

- 1 Before turning on the instrument, connect it and the standard equipment.
- 2 Warm up the instrument and standard equipment.
- 3 Press the [NEXT ENTER] key with the [ZERO CLR] key pressed.
The maintenance menu ("SP FC" and "End") is displayed.

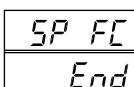

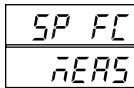

4 Press [▲] or [▼] until "End" on the lower line changes to "mEAS."

5 Press [NEXT ENTER] to display the calibration screen for measurement.

6 Select one of the measurement functions (DCV, DCA, Ω) using the [FUNCTION] key and press [RANGE] to select the range to calibrate. Three values (two for resistance) must be entered into the instrument from the standard equipment to calibrate one range.

The recommended value for the "FS" calibration point appears at the lower line of the display first.

For DCV or DCA

7 Enter the value into the instrument from the standard equipment. (If the recommended value has not been entered, enter the value), and then press [NEXT ENTER] for confirmation.

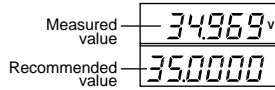

8 Press [24V OUT] to switch the function from "FS" to one of the remaining adjustment points, "0," and "-FS," and repeat step 7 for each of them referring to the recommended value shown on the lower line.

9 Press [HOLD] to write the calibrated value into the EEPROM of the instrument. Perform this operation for each range.

10 Repeat steps 6 to 9 for each range.

For Ω

7 Connect a high-accuracy resistance of the specified value and measure the resistance. Correct the value of the calibration point and press [NEXT ENTER] to confirm it.

8 Press the [24 V OUT] key and wire for the "0" calibration point and do the calibration. The calibration point is toggled by pressing the [24 V OUT] key between [FS] and [0].

9 Press [HOLD] to write the calibrated value into the EEPROM of the instrument. Perform this operation for each range.

10 Repeat steps 6 to 9 for each range.

Returning to the Measurement/Generation screen

11 Press [✱] to display [SP FC].

Press [▲] or [▼] until [End] appears on the lower line of the display.

12 Press the [NEXT ENTER] key to return to the Measurement/Generation screen.

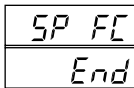
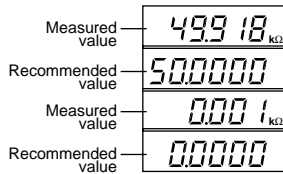
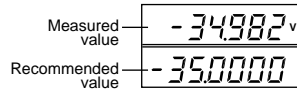

Note

- When calibrating the resistance measurement, if the resistance of the lead connecting terminals is not negligible, measure the resistance through the lead, and enter the value for the "0" calibration point into the instrument.
- When calibrating the resistance measurement, if an error in the value of precision resistance or the resistance of the wiring lead is not negligible, measure the resistance through the lead and high-accuracy resistance, and enter the value for the "FS" calibration point into the instrument.
- If you turn off the power before pressing the [HOLD] key, the set value is not stored.
- The calibrated value is retained even after turning off the power.

Recommended Value for Calibration Ranges and Points

Calibrating the Generation

The values of "FS" or "0" ("-FS," or "-0") vary depending on the object to measure. Send the appropriate value listed in the following table from the instrument to the standard equipment, and enter the value measured using the standard equipment into the instrument. If the entered value deviates from the one listed in the table by more than $\pm 20\%$, an error is assumed.

Function	Range	Unit	0	FS	-0	-FS	Remarks
DCV	100	mV	0.000	100.000	-	-	
	1	V	0.00000	1.00000	-	-	
	10	V	0.0000	10.0000	-	-	
DCA	20	mA	0.0000	20.0000	-	-	
	sink	mA	-0.0000	-20.0000	-	-	
Resistance	500(A1)	Ω	0.000	500.000	0.000	500.000	I= ± 1 mA
	500(A2)	Ω	0.000	500.000	0.000	500.000	I= ± 5 mA
	5(A1)	k Ω	0.00000	5.00000	0.00000	5.00000	I= ± 0.1 mA
	5(A2)	k Ω	0.00000	5.00000	0.00000	5.00000	I= ± 0.5 mA
	50(A)	k Ω	0.0000	50.0000	0.0000	50.0000	I= ± 50 mA

I: Current fed when calibrating the resistance generation. Feed a plus (+) current for "FS" and "0," and a minus (-) current for "-FS" and "-0."

Calibrating the Measurement

The values of "FS", "0", or "-FS" vary depending on the targets to measure. Enter an appropriate value listed in the table from the standard equipment into the instrument. If the entered or specified value for "FS" or "-FS" deviates from the one listed in the table by more than $\pm 20\%$ or the value for "0" deviates from the one listed in the table by more than ± 100 digits, an error is assumed.

Function	Range	Unit	0	FS	-FS	Remarks
DCV	500	mV	0.00	500.00	-500.00	
	5	V	0.0000	5.0000	-5.0000	
	35	V	0.000	35.000	-35.000	
DCA	20	mA	0.000	20.000	-20.000	
	100	mA	0.00	100.000	-100.000	
Resistance	500	Ω	0.000	500.00	-	
	5	k Ω	0.0000	5.0000	-	
	50	k Ω	0.000	50.000	-	

Commands for Calibration

The following communications commands are available for calibration. Before executing these commands, see the descriptions on pages 41 to 46.

AG

Turns the averaging function on and off/queries the current setting.

Syntax for setting AGm <terminator>
m=0: Averaging is off.
1: Averaging is on.

Syntax of query AG? <terminator>

Example of response AG1

CD

Specifies and queries the generation data.

Syntax for setting CDm <terminator>
"m" represents the generation value of DCV, DCA, or resistance.

Syntax of query CD? <terminator>

Example of response CD100.000

Description

- The generation value is configurable within a range as wide as can be keyed in at each range. Set the value, however, within the recommended limits of the given calibration point. Any setpoint exceeding these limits will result in error code 16. Example: For a calibration point of DCV 100 mV, the range is -999.999 to 999.999.

CL

Makes calibration item setting/queries the current setting.

Syntax for setting CLm <terminator>
m=3: Calibration of generation
4: Calibration of measurement

Syntax of query CL? <terminator>

Example of response CL3

CMF

Specifies the calibration function for measurement/queries the current setting.

Syntax for setting CMFm <terminator>
m=0: DCV
1: DCA
2: Resistance

Syntax of query CMF? <terminator>

Example of response CMF0

CP

Makes calibration point setting/queries the current setting.

Syntax for setting CPm <terminator>
Calibration for generation:

	<u>DCV</u>	<u>DCA*</u>	<u>Resistance</u>
m=0: FS	(S)FS	+FS	
1:0	(S)0	0	
2:-	-	-FS	
3:-	-	-0	

*(S) is for SINK.

Calibration for measurement:

	<u>DCV</u>	<u>DCA</u>	<u>Resistance</u>
m=0: +FS	+FS	+FS	+FS
1:0	0	0	
2:-FS	-FS	-	

Syntax of query CP? <terminator>

Example of response CP0

CS

Confirms the measured data when calibrating a measurement, and inputs and queries the DMM measured values.

Syntax for setting CSm <terminator>
"m" represents the measured value of DMM.

Syntax of query CS? <terminator>

Example of response CS1.00000

Description

- The measured value for a DMM is configurable within a range as wide as can be keyed in at each range. Set the value, however, within the recommended limits of the given calibration point. Any setpoint exceeding these limits will result in error code 16. Example: For a calibration point of DCV 10 V, the range is -99.9999 to 99.9999.

CSF

Specifies the calibration function for generation/queries the current setting.

Syntax for setting CSFm <terminator>
m=0: DCV
1: DCA
2: Resistance

Syntax of query CSF? <terminator>

Example of response CSF0

Description

- If the function is changed during generation, the generation is turned off. To turn on the generation, issue an SO command again.

CW

Writes the calibration data.

Syntax for setting CW <terminator>

Description

- The result of calculation is written to the EEPROM after completing calibration.
- If the calibration point is not set, error 16 occurs indicating a calibration error.

ESC S

Outputs a status byte.

Syntax for setting ESC S <terminator>

Description

- This outputs the status byte (n=0 to 127, n represents the decimal number converted from the binaries of bits 0 to 7) generated by the instrument. For details on the status byte, see page App-5.

H

Enables/Disables the header addition to the output data/queries the current setting.

Syntax for setting Hm <terminator>

m=0: Disabled
1: Enabled

Syntax for query H? <terminator>

Example of response H1

Description For details on the header, see the output format of measured values on page App-5.

KT

Selects the key type used and queries the current setting.

Syntax for setting KTm <terminator>

m=0: Up/Down key
1: Numeric keypad

Syntax of query KT? <terminator>

Example of response KT0

MO

Starts/stops measurement/queries the current setting.

Syntax for setting MOm <terminator>

m=0: Stop measurement
1: Start measurement

Syntax of query MO? <terminator>

Example of response MO1

MR

Specifies the calibration range for measurement/queries the current setting.

Syntax for setting MR m <terminator>

	<u>DCV</u>	<u>DCA</u>	<u>Resistance</u>
m=0:	500 mV	20 mA	500 Ω
1:	5 V	100 mA	5 kΩ
2:	35 V	-	50 kΩ

Syntax of query MR? <terminator>

Example of response MR0

OD

Outputs measured data.

Syntax for query OD <terminator>

Description For the output format of the measured data, see page App-5.

OE

Outputs error information.

Syntax for query OE <terminator>

Example of response ERR11

Description

- Outputs a recently occurred error.
- For the meanings of error numbers, see the troubleshooting section (page 40).

SO

Starts or ends generation/queries the current setting.

Syntax for setting SOm <terminator>

m=0: Stop generation
1: Start generation

Syntax of query SO? <terminator>

Example of response SO1

SR

Specifies the calibration range for generation/queries the current setting.

Syntax for setting SRm <terminator>

	<u>DCV</u>	<u>DCA</u>	<u>Resistance</u>
m= 0:	100 mV	20 mA	500 Ω (1 mA)
1:	1 V	-	5 kΩ (1 mA)
2:	10 V	SINK	50 kΩ
3:	-	-	500 Ω (5 mA)
4:	-	-	5 kΩ (5 mA)

Syntax of query SR? <terminator>

Example of response SR0

Description

- If the range is changed during generation, the generation is turned off. To turn on the generation, issue an SO command again.

SY

Switches between the normal and calibration modes/
queries the current setting.

Syntax for setting SYm <terminator>
m=0: Normal mode
1: Calibration mode

Syntax of query SY? <terminator>

Example of response SY1

Description

- If a communications command for the normal mode is received during the calibration mode, error 13 occurs.

TT

Selects the international temperature standard/queries
the current setting.

Syntax for setting TTm <terminator>
m=0: IPTS-68
1: ITS-90

Syntax of query TT? <terminator>

Example of response TT0

TU

Selects the temperature unit/queries the current setting.

Syntax for setting TUm<terminator>
m=0 : °C
1 : °F

Syntax of query TU?<terminator>

Example of response TU1

Replacing the Ni-Cd Batteries

The service life of Ni-Cd batteries is reduced if they are used repeatedly, even if they are completely charged. The interval between battery replacement differs depending on the operating conditions, but you should replace them approximately every two years or after recharging them 500 times. Battery pack replacement must be done as described on page 18.

Replacing the Backlighting EL

The EL for backlighting is consumable. The EL can be used continuously for approximately 5000 hours before its brightness falls by half. It is recommended that the EL be replaced after approximately 5000 hours of use (i.e., about 6 months at 24-hour continuous operation). It is not possible for user personnel to replace the EL, so please contact your nearest Yokogawa representative as listed on the back cover of this manual.

Replacing the Fuse



WARNING

- The fuse used must be of the specified rating in order to minimize the risk of a fire hazard. Never use a fuse of any other rating and never short-circuit the fuse holder to bypass the fuse.
- Before replacing the fuse, be sure to turn the power switch off, remove the connections from each input and output terminal and remove the power cord from the AC outlet.

Fuse Position and Replacement Method

The current input terminal accommodates a built-in fuse. A fuse is contained in the fuse holder as shown below. To replace the fuse, turn the fuse holder counterclockwise with your fingers to remove it, and then replace the fuse with a new one.

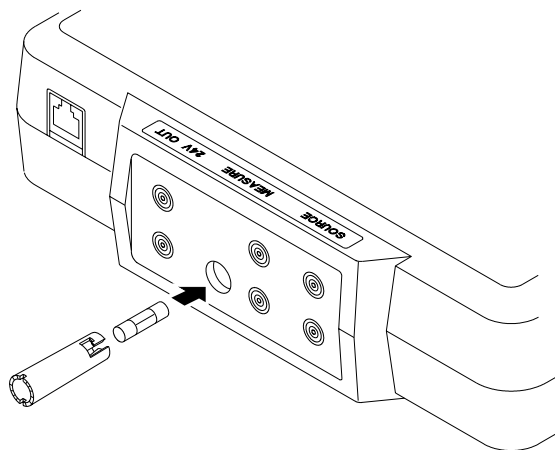

Fuse Ratings

When you order a spare fuse, specify the following part number.

Ratings	Part No.
250 V, 125mA, Quick acting	A1501EF

The following fuses are used in the instrument. It is not possible for the user to replace these fuses, so please contact your nearest YOKOGAWA representative as listed on the back of this manual.

Using place	Ratings	Part No.
Main board (F1)	250 V AC 315mA	A1445EF
Main board (F2)	250 V AC 1A	A1432EF

Specifications

The accuracy specifications vary depending on usage. The following specifications indicate the accuracy at an ambient temperature of $23^{\circ}\text{C} \pm 5^{\circ}\text{C}$, after performing auto-calibration, and are applicable for one year after calibration. They do not include measuring lead parts. The conditions for the temperature factors are 5°C or more but less than 18°C , and more than 28°C up to 40°C .

Generation Functions

DCV

Range	100 mV	1 V	10 V
Displaying Resolution	100.000 mV	1.00000 V	10.0000 V
Generating Range	-10 to 110 mV	-0.1 to 1.1 V	-1 to 11 V
Guaranteed Accuracy Range	0 to 100 mV	0 to 1 V	0 to 10 V
Accuracy (* ¹) \pm (% of setting + % of range)			
With EL turned off, without charging	0.02 + 0.01	0.02 + 0.005	0.02 + 0.005
With EL turned on, without charging	0.025 + 0.015	0.025 + 0.01	0.025 + 0.01
With charging	0.04 + 0.025	0.035 + 0.01	0.035 + 0.01
Temperature Coefficient \pm (% of setting + % of range) ^{°C}	0.003 + 0.002	0.002 + 0.001	0.002 + 0.001
Maximum Output (* ²)	-	10 mA	10 mA
Output Resistance	Approx. 6.5 Ω	Approx. 30 m Ω	Approx. 30 m Ω

*1 If you turn off the EL or stop charging while the EL is on and charging is in progress at the same time, it takes two hours for the accuracy in that condition to fall within the specified rating.

*2 If the applied output exceeds the maximum output, the output limiter operates. (A manual reset is required.)

DCA

Range	SOURCE 20 mA	SINK 20 mA* ¹
Displaying Resolution	20.000 mA	20.000 mA
Generating Range	0 to 22 mA	0 to -22 mA
Guaranteed Accuracy Range	0 to 20 mA	0 to -20 mA
Accuracy (* ²) \pm (% of setting + % of range)		
With EL turned off, without charging	0.025 + 0.015	0.025 + 0.03
With EL turned on, without charging	0.03 + 0.02	0.03 + 0.035
With charging	0.04 + 0.035	0.045 + 0.05
Temperature Coefficient \pm (% of setting + % of range) ^{°C}	0.003 + 0.003	0.003 + 0.003
Maximum Output (* ³)	24 V	28 V

*1 SINK: A function extracts the current of the specified value in the direction of the Hi terminal from an external voltage generating source (up to 28 V).

*2 If you turn off the EL or stop charging while the EL is on and charging is in progress at the same time, it takes two hours for the accuracy in that condition to fall within the specified rating.

*3 If the applied output exceeds the maximum output, the output limiter operates. (A manual reset is required.)

Resistance (*¹)

Range	500 Ω	5 k Ω	50 k Ω
Displaying Resolution	500.00 Ω	5.0000 k Ω	50.000 k Ω
Generating Range	0 to 550 Ω	0 to 5.5 k Ω	0 to 55 k Ω
Guaranteed Accuracy Range	0 to 500 Ω	0 to 5 k Ω	0 to 50 k Ω
Accuracy (* ²) \pm (% of setting + % of range)			
With EL turned off, without charging	0.02 + 0.02	0.05 + 0.03	0.1 + 0.1
With EL turned on, without charging	0.025 + 0.02	0.06 + 0.03	0.11 + 0.11
With charging	0.035 + 0.1	0.065 + 0.1	0.12 + 0.3
Temperature Coefficient \pm (% of setting + % of range) ^{°C}	0.002 + 0.01	0.002 + 0.01	0.002 + 0.03
Maximum Output	2 V	2 V	2 V
Remarks	1 mA \leq measuring current \leq 5 mA, and output voltage of 2 V or less	0.1 mA \leq measuring current \leq 1 mA, and output voltage of 2 V or less	0.01 mA \leq measuring current \leq 0.1 mA, and output voltage of 2 V or less

*1 Resistance Generation: The equivalent resistance generation system from detecting the resistance measurement current and the generating voltage drop. The specifications are valid within the measured current and voltage shown in the remarks column.

*2 If you turn off the EL or stop charging while the EL is on and charging is in progress at the same time, it takes two hours for the accuracy in that condition to fall within the specified rating.

Thermocouple

Range (*1)	K	E	J	T	N	R	B
Displaying Resolution	1000.0°C	1000.0°C	1000.0°C	100.0°C	1000.0°C	1000°C	1000°C
Generating Range	-200 to 1372°C	-250 to 1000°C	-210 to 1200°C	-250 to 400°C	-200 to 1300°C	-40 to 1767°C	400 to 1820°C
Guaranteed Accuracy Range	Same as the generating range						
Accuracy (*2, *3)							
With EL turned off, without charging	-200 to -100°C:0.6°C -100 to 400°C:0.5°C 400 to 1200°C:0.7°C 1200 to 1372°C:0.9°C	-250 to -200°C:1.2°C -200 to -100°C:0.6°C -100 to 600°C:0.5°C 600 to 1000°C:0.6°C	-210 to -100°C:0.6°C -100 to 800°C:0.5°C 800 to 1200°C:0.7°C	-250 to -200°C:1.5°C -200 to 400°C:0.5°C	-200 to -100°C:1.0°C -100 to 900°C:0.7°C 900 to 1300°C:0.8°C	-40 to 100°C:1.5°C 100 to 1767°C:1.2°C	400 to 600°C:2.0°C 600 to 800°C:1.5°C 800 to 1820°C:1.1°C
With EL turned on, without charging	-200 to -100°C:0.7°C -100 to 400°C:0.6°C 400 to 1200°C:0.8°C 1200 to 1372°C:1.0°C	-250 to -200°C:1.4°C -200 to -100°C:0.7°C -100 to 600°C:0.6°C 600 to 1000°C:0.7°C	-210 to -100°C:0.7°C -100 to 800°C:0.6°C 800 to 1200°C:0.8°C	-250 to -200°C:1.9°C -200 to 400°C:0.6°C	-200 to -100°C:1.2°C -100 to 900°C:0.8°C 900 to 1300°C:0.9°C	-40 to 100°C:1.9°C 100 to 1767°C:1.6°C	400 to 600°C:2.4°C 600 to 800°C:1.9°C 800 to 1820°C:1.5°C
With charging	-200 to -100°C:1.0°C -100 to 400°C:0.9°C 400 to 1200°C:1.1°C 1200 to 1372°C:1.3°C	-250 to -200°C:1.9°C -200 to -100°C:1.0°C -100 to 600°C:0.9°C 600 to 1000°C:1.0°C	-210 to -100°C:1.0°C -100 to 800°C:0.9°C 800 to 1200°C:1.1°C	-250 to -200°C:3.0°C -200 to 400°C:0.9°C	-200 to -100°C:1.7°C -100 to 900°C:1.1°C 900 to 1300°C:1.2°C	-40 to 100°C:3.0°C 100 to 1767°C:2.6°C	400 to 600°C:3.4°C 600 to 800°C:3.0°C 800 to 1820°C:2.5°C
Temperature Coefficient	0.05°C	-250 to -200°C:0.1°C -200 to 1000°C:0.05°C	0.05°C	-250 to -200°C:0.2°C -200 to 400°C:0.05°C	-200 to -100°C:0.1°C -100 to 1300°C:0.05°C	0.2°C	0.2°C
Thermocouple Output Internal Resistance	Approx. 6.5 Ω						

ReferenceJunction Compensation:Based on the optional RJC sensor. If the output correction is performed based on the reference contact temperature, the accuracy of the sensor must be added. The output correction is performed every 10 seconds.

Specifications of RJC sensor:Measuring range: -10 to 50°C

Accuracy between 18 and 28°C: ±0.5°C (including the instrument)

Accuracy between -10 and 18°C, 28 to 50°C: ±1°C (including the instrument)

Length of the cord: Approx. 1.5 m

*1 Complies with both JIS-C1602-1981 and 1995

*2 RJC accuracy is excluded

*3 If you turn off the EL or stop charging while the EL is on and charging is in progress at the same time, it takes two hours for the accuracy in that condition to fall within the specified rating.

Resistance Temperature Detector (*1)

Range	PT100
Displaying Resolution	100.0°C
Generating Range	-200 to 850°C
Guaranteed Accuracy Range	Same as the generating range
Accuracy (*2)	
With EL turned off, without charging	-200 to 0°C:0.3°C 0 to 400°C:0.5°C 400 to 850°C:0.8°C
With EL turned on, without charging	-200 to 0°C:0.4°C 0 to 400°C:0.6°C 400 to 850°C:0.9°C
With charging	-200 to 0°C:0.6°C 0 to 400°C:0.8°C 400 to 850°C:1.1°C
Temperature Coefficient	0.04°C

*1 Resistance Generation: The equivalent resistance generation system from detecting the resistance measurement current and the generating voltage drop. The specifications are valid within the measured current and voltage shown in the remarks column. The accuracy is at measured current of 1 to 5 mA (PT100)

*2 If you turn off the EL or stop charging while the EL is on and charging is in progress at the same time, it takes two hours for the accuracy in that condition to fall within the specified rating.

Frequency, Pulse Signal

Range	100 Hz	1000 Hz	10 kHz	50 kHz
Displaying Resolution	100.0 Hz	1000 Hz	10.0 kHz	50 kHz
Generating Range	1 to 110 Hz	90 to 1100 Hz	0.9 to 11.0 kHz	9 to 50 kHz
Guaranteed Accuracy Range	1 to 100 Hz	100 to 1000 Hz	1 to 10 kHz	10 to 50 kHz
Accuracy	1 digit	1 digit	1 digit	1 digit
Maximum Output	10 mA	10 mA	10 mA	10 mA
Waveform	Rectangular wave approx. 50% of duty factor			
Output Level	10 V DC range			
Output Level Accuracy	± (10% of setting + 10 mV)			
Number of pulses	1 to 60000 cycles			

Measurement Function

DCV

Range	500 mV	5 V	35 V
Displaying Resolution	500.00 mV	5.0000 V	35.000 V
Displaying Range	-599.99 to 599.99 mV	-5.9999 to 5.9999 V	-41.999 to 41.999 V
Guaranteed Accuracy Range	-500.00 to 500.00 mV	-5.0000 to 5.0000 V	-35.000 to 35.000 V
Accuracy (*) ± (% of reading +% of range)			
With EL turned off, without charging	0.02 + 0.01	0.02 + 0.01	0.02 + 0.015
With EL turned on, without charging	0.025 + 0.01	0.025 + 0.01	0.025 + 0.015
With charging	0.035 + 0.02	0.035 + 0.02	0.035 + 0.02
Temperature Coefficient ± (% of reading +% of range)/°C	0.002 + 0.001	0.002 + 0.001	0.002 + 0.001
Input Resistance	1 GΩ or more	Approx. 1 MΩ	Approx. 1 MΩ

* If you turn off the EL or stop charging while the EL is on and charging is in progress at the same time, it takes two hours for the accuracy in that condition to fall within the specified rating.

DCA

Range	20 mA	100 mA
Displaying Resolution	20.000 mA	100.00 mA
Displaying Range	-23.999 to 23.999 mA	-119.99 to 119.99 mA
Guaranteed Accuracy Range	-20.000 to 20.000 mA	-100.00 to 100.00 mA
Accuracy (*) ± (% of reading +% of range)		
With EL turned off, without charging	0.025+0.02	0.04+0.03
With EL turned on, without charging	0.03+0.02	0.045+0.03
With charging	0.04+0.03	0.055+0.04
Temperature Coefficient ± (% of reading +% of range)/°C	0.002+0.001	0.002+0.001
Input Resistance	20 Ω or less	

* If you turn off the EL or stop charging while the EL is on and charging is in progress at the same time, it takes two hours for the accuracy in that condition to fall within the specified rating.

Resistance

Range	500 Ω	5 kΩ	50 kΩ
Displaying Resolution	500.00 Ω	5.0000 kΩ	50.000 kΩ
Displaying Range	0 to 599.99 Ω	0 to 5.9999 kΩ	0 to 59.999 kΩ
Guaranteed Accuracy Range	0 to 500.00 Ω	0 to 5.0000 kΩ	0 to 50.000 kΩ
Accuracy (*) ± (% of reading +% of range)			
With EL turned off, without charging	0.055+0.015	0.055+0.015	0.055+0.02
With EL turned on, without charging	0.065+0.02	0.065+0.02	0.065+0.03
With charging	0.09+0.03	0.09+0.03	0.09+0.04
Temperature Coefficient ± (% of reading +% of range)/°C	0.005+0.002	0.005+0.002	0.005+0.002
Measurement Current	Approx. 1 mA	Approx. 100 μA	Approx. 10 μA

* If you turn off the EL or stop charging while the EL is on and charging is in progress at the same time, it takes two hours for the accuracy in that condition to fall within the specified rating.

Generation Section

Response Time	10 ms 1 V DC, 10 V DC ranges: The time necessary for the output to be settled within the accuracy range from when it started to vary. 10 ms 500 Ω range: The time necessary for the output to be settled within the accuracy range from when the regulated current was fed. (Including RTD output) 300 ms other than the above ranges: The time necessary for the output to be settled within the accuracy range from when it started to vary.
Voltage limiter	28.5 V or more
Current limiter	12 mA or more (only for functions of DCV, frequency, pulse)
Load condition	0.01 μF or less (for DCV, Ω, TC, RTD, frequency, pulse), 100 μH or less (DC mA)
Thermocouple generation	Without external reference contact, zero-point reference output With external reference contact (B9638CR), reference temperature measuring accuracy ±0.5°C (where the measured temperature is 23°C±5°C) ±1.0°C (where the measured temperature is -10 to 18°C or 28 to 50°C)

Measurement Section

Display Update Time	1 sec.
Max. Input Voltage, Current	Voltage terminal 42 V, Current terminal 120 mA
Current Terminal Input Protection	Fuse, Part No. A1501EF, 250 V, 125 mA, Quick acting
CMRR	120 dB or more (50/60 Hz), RS = 1 kΩ
NMRR	60 dB or more (50/60 Hz)
Release Voltage for Resistance Measurement	max 4.5 V
Average Number for Moving Average	5 sampling data

24 V DC Supply Section

Output Voltage	24 V DC ± 1 V
Max. Output Current	22 mA DC
Output Protection	Output is turned off at 30 mA or more

Communications Function

RS-232-C Interface	9-pin D-SUB connector
Transfer Method	Start-stop synchronization system
Transfer Rate	150, 300, 600, 1200, 2400, 4800, 9600 bits/s
Function Specifications	Talk-only/Normal mode, Handshaking mode, data format selection available

Common Specifications

Complying safety standard	General safety: EN61010 · Overvoltage category II (CAT II) · Pollution degree 2 EMC : IEC1326-1:1997 DRAFT, IEC1326-10:1996 DRAFT · Except, use a double shielded cable for the RS-232-C cable and separate the RS-232-C cable and the measuring lead by 50 mm or more. · The cable layout during the emission test was as follows. The output lead of the generation section was bent perpendicularly to the left at 20 cm from the terminal section. The output lead of 24VOUT was bent perpendicularly to the right at 20 cm from the terminal section. The cord from the AC adapter was bent perpendicularly towards the front at 5 cm from the connector. The measuring lead, RJC sensor cable and the RS-232-C cable was positioned perpendicular to the terminal section and the connector in a straight line. · The output voltage range of the AC adapter is 15 V DC ±0.75 V.
---------------------------	--

The influence under the immunity environment is as follows

Function	Test Condition		
	Range	Setting Value	Accuracy
Generation	1V	0.5V	±5% of range
	20mA	10mA	±5% of range
	50kΩ	10kΩ	±5% of range
Measurement	5V	1V	±20% of range
	20mA	0mA	±30% of range
	50kΩ	10kΩ	±20% of range

Power Supply	AC adapter, Ni-Cd battery pack, or commercially available AA alkaline cells; the Ni-Cd battery pack can be recharged only within the instrument.
Charging the battery pack AC adapter (optional)	Timer charging by the instrument (approximately 10 hours)
Ni-Cd Battery Pack (optional)	Input: 100 to 240 V AC, 50/60 Hz, 40 to 55 VA Permitted Input Voltage Range: 90 to 264 V AC Permitted Input Frequency Range: 48 to 62 Hz 1200 mAh, 9.6 V, recycle-designated part, service life of 2 years (varies according to the operating conditions), part number B9914PS Continuous operating time for guidance: With generating 5 V DC (with 500 Ω load), and operating measuring function: Approx. 7.5 hours With generating 20 mA (with 1 k Ω load), operating measuring function, 24 V DC power supply, EL lit: Approx. 2.5 hours
AA Cells	Eight AA alkaline cells Continuous operating time for guidance: With generating 5 V DC (with 500 Ω load), and operating measuring function: Approx. 10 hours With generating 20 mA (with 1 k Ω load), operating measuring function, 24 V DC power supply, EL lit: Approx. 2 hours
Automatic Power Off:	Approximately 30 minutes under the following conditions: No key or communication operation is performed while being run on batteries.
Display Backlighting	Segmented LCD, EL backlighting
Warm-up Time	Approx. 5 minutes
Power Consumption	55 VA or less
Insulation Resistance	20 M Ω or more for one minute at 500 V DC (between terminals/each terminal and AC adapter power line)
Withstanding Voltage	350 V AC for one minute (between terminals) 1500 V AC for one minute (between each terminal and AC power line)
Operating Temperature/Humidity Ranges	For generation or measurement (normal), or charging without generation or measurement running: 5 to 40°C, 20 to 80% RH (no condensation) For charging with generation or measurement running: 5 to 30°C, 20 to 80% RH (no condensation)
Storage Temperature/Humidity Range	-20 to 45°C, 90% RH or less (No condensation allowed)
I/O terminals	Maximum applied voltage is less than 42 V _{peak} and CAT II between terminals/each terminal and ground. Except, negative 24 V _{OUT} terminal is 18 V _{peak} or less.
Operating altitude	Max. 2000 m
External Dimensions	237 x 137 x 63 mm (does not include projections)
Weight	Approx. 1.2 kg (including 8 dry cells)

External Dimensions

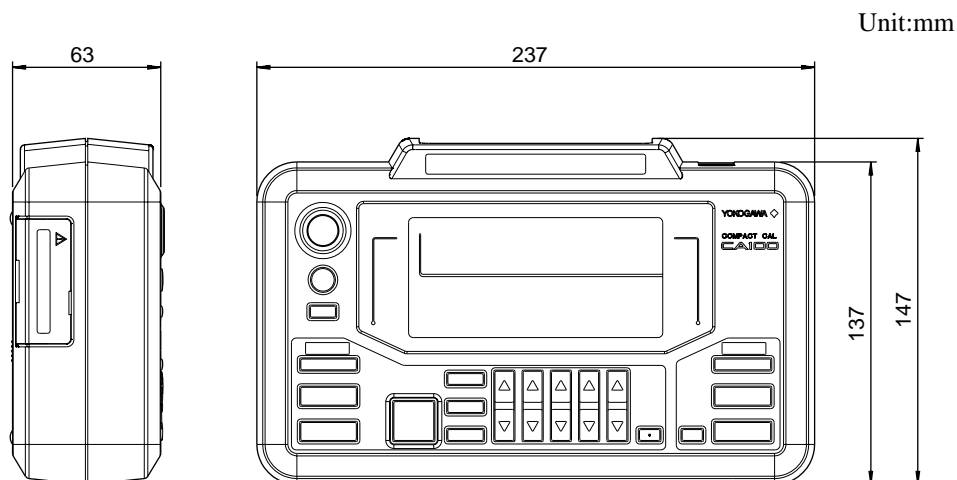

Appendix

Communication Commands

AS

Makes the current function setting/queries the current setting.

Syntax for setting ASm <terminator>
m=0: Source
1: SINK

Syntax for query AS? <terminator>

Example of response AS0

BL

Turns the backlighting on and off/queries the current setting.

Syntax for setting BLm <terminator>
m=0: Off
1: On

Syntax for query BL? <terminator>

Example of response BL1

BT

Starts charging the battery pack when being connected to the AC power supply.

Syntax for setting BT <terminator>

Description

- Issuing this command without connecting to the AC power supply results in error 14.
- Error code 15 occurs if there is no Ni-Cd battery connected.

DL

Selects the terminator type used for output data/queries the current setting.

Syntax for setting DLm <terminator>
m=0: CR + LF
1: CR
2: LF

Syntax for query DL? <terminator>

Example of response DL0

DW

Moves down the "m-th" digit of the generated value by one digit.

Syntax for setting DWm <terminator>
m=1 to 5

Description

- This command has no query.
- This is valid only when the up/down key is selected.

ESC C or RC

Initializes the set information of the instrument.

Syntax for setting ESC C <terminator>
RC <terminator>

Description

- When initializing the information using these commands, the following are not initialized:
- Communication items
- Key type
- Average

- International temperature standard
- Temperature unit

ESC S

Outputs a status byte.

Syntax for setting ESC S <terminator>

Description

- This outputs the status byte (n=0 to 127, n represents the decimal number converted from the binaries of bits 0 to 7) generated by the instrument. For details on the status byte, see page App-5.

H

Enables/Disables the header addition to the output data/queries the current setting.

Syntax for setting Hm <terminator>
m=0: Disabled
1: Enabled

Syntax for query H? <terminator>

Example of response H1

Description

- For details on the header, see the output format of measured values on page App-5.

HD

Enables/Disables data hold/queries the current setting.

Syntax for setting HDm <terminator>
m=0: Display update
1: Display hold

Syntax for query HD? <terminator>

Example of response HD0

Description

- Although the display is in "hold" status, the system continues updating measurement data.

IM

Makes the status byte mask setting/queries the current setting.

Syntax for setting IMm <terminator>
m=0 to 63
1: Measurement end
2: Output change end
4: Syntax error
8: Overrange
16: Loop power supply error
32: Error on output

Syntax for query IM? <terminator>

Example of response IM6

Description:

- Set the value representing the information to be retrieved. If more than one bit is to be retrieved, the sum of the number of those bits must be set as "m." For instance, if 3 bits, "Measurement end," "Syntax error," and "Overrange," are to be retrieved, set "m" to 13 (1+4+8=13).
- For details on status bytes, see page App-5.

MF

Sets the measuring function/queries the current setting.

Syntax for setting MFm <terminator>
m=0: DCV
1: DCA
2: Resistance

Syntax for query MF? <terminator>

Example of response MF1

MO

Starts/Stops measurement/queries the current setting.

Syntax for setting MOm <terminator>
m=0: Stop
1: Start

Syntax for query MO? <terminator>

Example of response MO1

MR

Sets the measurement range/queries the current setting.

Syntax for setting MRm <terminator>
DCV DCA Resistance
m=0: 500 mV 20 mA 500 Ω
1: 5V 100 mA 5 kΩ
2: 35 V - 50 kΩ

Syntax for query MR? <terminator>

Example of response MR0

OB

Queries the battery charge state.

Syntax for query OB <terminator>

Description The following are the responses:
0: Off
1: Charging
2: Charging completed

OD

Outputs measured data.

Syntax for query OD <terminator>

Description For the output format of the measured data, see page App-5.

OE

Outputs error information.

Syntax for query OE <terminator>

Example of response ERR11

Description

- Outputs the most-recently-generated error.
- For the meanings of error numbers, see the troubleshooting section (page 40).

OR

Queries whether an RJC sensor is connected.

Syntax for query OR <terminator>

Description The following are the responses:
0: Connected
1: Not connected

OS

Outputs the setting information.

Syntax for query OS <terminator>

Description

- For the output format of the measured data, see page App-5.

SC

Enable/Disable auto-zero calibration/queries the current setting.

Syntax for setting SCm <terminator>
m=0: Enable auto-zero calibration
1: Disable auto-zero calibration

Syntax for query SC? <terminator>

Example of response SC0

SD

Sets generated value/queries the current setting.

Syntax for setting SDm <terminator>

DCV
 (100 mV) m = -10.000 to 110.000
 (1 V) m = -0.10000 to 1.10000
 (10 V) m = -1.0000 to 11.0000

DCA
 (20 mA) m = 0.000 to 22.000
 (SINK) m = -22.000 to 0.000

Resistance
 (500 Ω) m = 0.00 to 550.000
 (5 kΩ) m = 0.0000 to 5.5000
 (50 kΩ) m = 0.0000 to 55.000

RTD
 (PT100) m = -200.0 to 850.0

TC
 (K) m = -200.0 to 1372.0
 (E) m = -250.0 to 1000.0
 (J) m = -210.0 to 1200.0
 (T) m = -250.0 to 400.0
 (R) m = -40.0 to 1767
 (N) m = -200.0 to 1300.0
 (B) m = 400.0 to 1820

Frequency/Pulse frequency
 (100 Hz) m = 1.0 to 110.0
 (1 kHz) m = 90 to 1100
 (10 kHz) m = 0.9 to 11.0
 (50 kHz) m = 9 to 50

Frequency DCV/Pulse DCV
 (10 V) m = -1.0000 to 11.0000

Pulse
 m=1 to 60000

Syntax for query SD? <terminator>

Example of response SD100.000

SF

Sets the generated function/queries the current setting.

Syntax for setting SFm <terminator>

m=0: DCV
 1: DCA
 2: Resistance
 3: TC (thermocouple)
 4: RTD (resistance temperature detector)
 5: Frequency
 6: Frequency DCV
 7: Pulse
 8: Pulse DCV
 9: Pulse frequency

Syntax for query: SF? <terminator>

Example of response SF0

Description During generation, if the function is changed, generation is turned off. The generated value is also reset to zero.

SO

Starts/Stops generation/queries the current setting.

Syntax for setting SOm <terminator>

m=0: Generation stop
 1: Generation start

Syntax for query SO? <terminator>

Example of response SO1

SR

Sets the generation range/queries the current setting.

Syntax for setting SRm <terminator>

	DCV	Resistance
m=0:	100 mV	500 Ω
1:	1 V	5 kΩ
2:	10 V	50 kΩ

	RTD	TC	Frequency/Pulse frequency
m=0:	-	B	100Hz
1:	PT100	E	1 kHz
2:	-	J	10 kHz
3:	-	K	50 kHz
4:	-	N	-
5:	-	R	-
6:	-	T	-

Syntax for query SR? <terminator>

Example of response SR1

Description

- Frequency DCV and pulse DCV are fixed in a 10 V range. The pulse function has no range setting, either.
- During generating, if the range is changed, generation is turned off. The generated value is also reset to zero.
- SR command is unavailable for switching the current function source/SINK. Use the AS command.

SY

Switches between the normal and calibration modes/queries the current setting.

Syntax for setting SYm <terminator>

m=0: Normal mode
 1: Calibration mode

Syntax for query SY? <terminator>

Example of response SY1

Description

- If a command for the calibration mode is received during the normal mode, error 13 occurs.

UP

Moves up the "m-th" digit of the generated value by one digit.

Syntax for setting UPm <terminator>

m=1 to 5

Description:

- This command has no query.
- This is valid only when the UP/DOWN key is selected.

VO

Start/Stop the 24 V DC power supply/queries the current setting.

Syntax for setting VOm <terminator>
m=1: Stops supply
0: Starts supply

Syntax for query VO? <terminator>

Example of response VO1

Status Byte Format (for <ESC> command)

bit7 0 (Fixed)	bit6 1 (Fixed)	bit5 Output error	bit4 Loop power supply error	bit3 Overrange error	bit2 Syntax error	bit1 Output change end	bit0 Measure- ment end
----------------------	----------------------	-------------------------	------------------------------------	----------------------------	-------------------------	---------------------------------	------------------------------

bit 7: Fixed to 0

bit 6: Fixed to 1

bit 5: This is set to 1 if an error occurs during output. It is retained until a status byte is fetched.

bit 4: This is set to 1 if an error occurs in the loop power supply. It is retained until a status byte is fetched.

bit 3: This is set to 1 if an overrange occurs. It is retained until a status byte is fetched.

bit 2: This is set to 1 if an inhibited operation or command is processed, a command cannot be interpreted, or an out-of-range parameter is specified. It is retained until a status byte is fetched.

bit 1: This is set to 1 if the output value varies with the output in status and stabilizes. It is retained until a status byte is fetched.

bit 0: This is set to 1 if data are fixed when measuring. It is retained until a status byte is fetched.

Output Format of Measured Data

Individual Data Structure

Each data item consists of a header section (4 bytes), data section (10 bytes), and a terminator.

Header	Data	Terminator
--------	------	------------

Header section

The header section consists of 4 bytes (h1 to h4).

h1	h2	h3	h4
----	----	----	----

h1: Data type

V: Voltage

A: Current

O: Resistance

h2 and h3: Measurement division

DC: Direct current

R2: Two-wire resistance

h4: Data status

N: Normal

A: Average

O: Overrange

E: Abnormal data (no data)

Data section

The data section consists of 10 bytes (d1 to d10).

d1	d2	d3	d4	d5	d6	d7	d8	d9	d10
----	----	----	----	----	----	----	----	----	-----

d1 to d7: Floating-point, fixed-point part

d8 to d10: Floating-point characteristic

If the unit has no "k" or "m," it is represented as "E+0."

If the unit has a "k" or "m," "k" is represented as "E+3," and "m" is represented as "E-3."

Data when overrange occurs

99999.E+3

Data when no data reside

99999.E+3

Output Format for Talk-Only or Printer Mode

For the talk-only or printer mode (when connected with a printer), the generated set-up value or measured value is output.

Example of output

```
Source: Function      DCV
        Range        100mV
        Data         100.000mV
Measure: Average      OFF
        Range        35V
        Data         0.000V
```

Output Format for Setting Information

```
Measure      on and off
Function     DCV/DCA/R
Range        Set range
Source       on and off
Function     Set function
Range        Set range
Data         Generation level value
24 V Output  on and off
Light        on and off
Charge       Off/Charging/Completed
```

Example of Output:

```
Measure On
Function DCV
Range 35V
Source ON
Function DCV
Range 100mV
Data 100.000
24V Output OFF
Charge OFF
```

Sample Program

```
'*****
'*
'*      CA100 COMAPCT CAL (RS-232-C)
'*
'*      Output 50 mV in DCV 100 mV range
'*
'******
'
      OPEN "COM1:9600,N,8,1,CS0,DS0,LF" FOR RANDOM AS 1      'Set communication mode
'
      PRINT #1, "RC"          'Initialize settings
      PRINT #1, "SF0"        'Set to DCV function
      PRINT #1, "SR0"        'Set to 100 mV range
      PRINT #1, "SD50.000"   'Set the generated value to 50 mV
      PRINT #1, "SO1"        'Start generation
'
      CLOSE #1
      END

'*****
'*
'*      CA100 COMAPCT CAL (RS-232-C)
'*
'*      Make 100 measurements, determine the max. and min. values
'*      and display the result.
'*
'******
'
      OPEN "COM1:9600,N,8,1,CS0,DS0,LF" FOR RANDOM AS 1      'Set communication mode
'
      DIM RDATA$(100)
      COUNT = 0: MAXNO = 0: MINNO = 0: ERRNO = 0:      'Initialize parameters
      MCOUNT = 100:      'Set measurement count
      LF$ = CHR$(&HA)

      PRINT #1, "RC":      'Initialize settings
      PRINT #1, "H1":      'Turn ON header
      PRINT #1, "M01":      'Start measurement
      PRINT #1, "MFO":      'Set to DCV function
      PRINT #1, "MRO":      'Set to 100 mV range
      PRINT #1, CHR$(&H1B) + "S":      'Initialize status byte
      LINE INPUT #1, STB$
      CLS
' Main routine
LOOP1:
      PRINT #1, CHR$(&H1B) + "S":      'Get status byte
      LINE INPUT #1, STB$
      IF LEFT$(STB$, 1) = LF$ THEN STB$ = MID$(STB$, 2)
      SB = VAL(STB$)
      IF (SB AND 8) <> 0 THEN GOTO ERRPROC:      'Over range H
      IF (SB AND 1) <> 0 THEN GOSUB READM:      'Measurement complete?
      LOCATE 1, 1: PRINT COUNT; "Samples"
      IF COUNT = MCOUNT THEN GOTO MEASEND
      FOR I = 0 TO 10000: NEXT I      'Wait
```

```

GOTO LOOP1
'
MEASEND:
CLS
FOR Y = 0 TO MCOUNT / 4 - 1
  YPOS = CSRLIN
  FOR X = 0 TO 3
    XPOS = X * 20 + 1
    LOCATE YPOS, XPOS
    PRINT RDATA$(X + Y * 4) + "(" + STR$(X + Y * 4) + "): 'Display measurement result
    IF YPOS = 24 THEN YPOS = YPOS - 1
  NEXT X
NEXT Y
PRINT "MAX=", RDATA$(MAXNO): 'Display max. value
PRINT "MIN=", RDATA$(MINNO): 'Display min. value
PRINT "ERR=", ERRNO:
'Display the number of occurrences of over range
CLOSE #1
END
' Routine to acquire measured data
READM:
PRINT #1, "OD": 'Get measured data
LINE INPUT #1, STRDATA$
IF LEFT$(STRDATA$, 1) = LF$ THEN STRDATA$ = MID$(STRDATA$, 2)
STS$ = MID$(STRDATA$, 4, 1)
IF STS$ = "E" THEN RETURN: 'Data abnormal?
IF STS$ = "O" THEN RETURN: 'Over range H
SDATA = VAL(MID$(STRDATA$, 5, 7)): 'Convert measured data
RDATA$(COUNT) = MID$(STRDATA$, 5, 10): 'Get numerical data section
IF COUNT = 0 THEN MAX = SDATA
IF COUNT = 0 THEN MIN = SDATA
IF MAX < SDATA THEN GOSUB GETMAX
IF MIN > SDATA THEN GOSUB GETMIN
COUNT = COUNT + 1
RETURN
' Routine to obtain the max. value
GETMAX:
MAX = SDATA
MAXNO = COUNT
RETURN
GETMIN:
' Routine to obtain the min. value
MIN = SDATA
MINNO = COUNT
RETURN
' Error routine
ERRPROC:
ERRNO = ERRNO + 1
GOTO LOOP1

```

Index

24 V DC output terminal	13
24 V DC power supply	32

A Page

AC adapter	3
Connection	17
Accessories (optional)	3
Auto-zero calibration	23
Averaging	10
Setting	21

B Page

Backlight	20
Baud rate	37
Block diagram	9

C Page

Calibration	41
Calibrating the generation function	42
Calibrating the measurement function	44
Commands	47
Command list	47, App-1
Communication command	App-1
Communications function	34
Current sinking function	25

D Page

Data format	37
Display hold	31
Dry cells	3
Low-battery indicator	11, 17
Life	17
Installation	16

E Page

Error code	40
External dimensions	55

F Page

Ferrite core	3
Installation	15
Front panel	10
Fuse, replacement of	50

G Page

Generation	9, 23
DC current (DCA)	24
DC voltage (DCV)	24
Frequency	28

Pulse signal	28
Resistance	24
Resistance temperature detector (RTD)	25
Thermocouple (TC)	25

H Page

Handshaking	36
-------------------	----

I Page

Input terminals	13
Connecting	30
International temperature standard selection	21

K Page

Key-type selection	21
--------------------------	----

L Page

LCD screen	11
------------------	----

M Page

Measurement	9,30
DC current (DCA)	31
DC voltage (DCV)	31
Resistance	31
Model name	2

N Page

Ni-Cd battery pack	3
Charging	18
Low-battery indicator	11, 20
Installation & replacement	18, 50
Operating time	20
Normal mode	36

O Page

Output terminal	13
Connecting	23
Output format	
For measured data	App-5
For setting information	App-6
For the talk-only or printer mode	App-6
Output limiter	25
Overrange	31

P Page

Power switch	10, 20
Printer mode	36, 39

R	Page
Reference Junction Compensation	27
RJC sensor	27
RS-232-C interface	33
Baud rate	37
Commands	47, App-1
Communications modes	36
Connector	12, 34
Data format	37
Handshaking	36
Terminator	37

S	Page
Sample program	App-7
Side panel	12
Specifications	51
Standard accessories	3
Status byte format	App-5
Suffix code	2

T	Page
Talk-only mode	36, 39
Temperature unit selection	21
Terminator	37, 39